

HKQ0603W4N3J-T

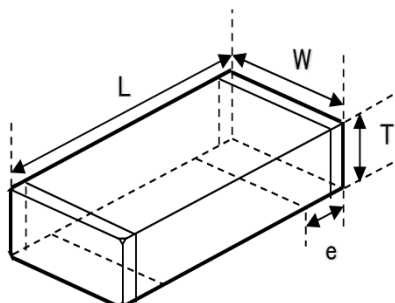

■ Features

- Item Summary
4.3nH±5%, 0.4A, 0201/0603 (EIA/JIS)
- Lifecycle Stage
Mass Production
- Standard packaging quantity (minimum)
Taping paper 15000pcs

■ Products characteristics table

Inductance	4.3 nH ± 5 %
Case Size (EIA/JIS)	0201/0603
Rated Current (max)	0.4 A
DC Resistance (max)	0.3 Ω
Q (min)	15
Q (typ)	21
LQ Measuring Frequency	500 MHz
Self Resonant Frequency (min)	6000 MHz
Operating Temp. Range	-55 to +125 °C
Temperature characteristic (Inductance change)	± 10 %
RoHS2 Compliance (10 subst.)	Yes
REACH Compliance (173 subst.)	Yes
Halogen Free	Yes
Soldering	Reflow

■ External Dimensions

Dimension L	0.6 ±0.03 mm
Dimension W	0.3 ±0.03 mm
Dimension T	0.3 ±0.03 mm
Dimension e	0.15 ±0.05 mm

2017.04.30

The data is reference only. Electrical characteristics vary depending on environment or measurement condition. TAIYO YUDEN reserves the right to make change to the Date at any time without notice. Before making final selection, please check product specification.