

DATA SHEET

SKY67013-396LF: 600-1500 MHz Low-Noise, Low-Current Amplifier

Applications

- ISM band receivers
- General purpose LNAs

Features

- Low NF: 0.85 dB @ 900 MHz
- Gain: 14 dB @ 900 MHz
- Flexible supply voltage from 1.8 to 5.0 V
- Adjustable supply current for higher IIP3
- Improved NF and linearity compared to SiGe LNAs
- Incorporates on-die stability structures
- Miniature DFN (8-pin, 2 x 2 mm) package (MSL1 @ 260 °C per JEDEC J-STD-020)



Skyworks Green™ products are compliant with all applicable legislation and are halogen-free. For additional information, refer to *Skyworks Definition of Green™*, document number SQ04-0074.

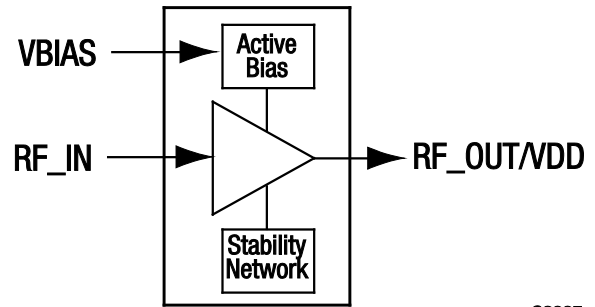

S2395

Figure 1. SKY67013-396LF Block Diagram

Description

The SKY67013-396LF is a GaAs, pHEMT Low-Noise Amplifier (LNA) with an integrated active bias. The advanced GaAs pHEMT enhancement mode process provides excellent return loss, low noise, and high linearity.

The device offers the ability to externally adjust the supply current. The supply voltage is applied to the RF-OUT/VDD pin through an RF choke inductor. The VBIAS pin should be connected to the RF_OUT/VDD pin through an external resistor to control the supply current. Both RF_OUT/VDD and RF_IN pins should be DC blocked to ensure proper operation.

The SKY67013-396LF is manufactured in a compact, 2 x 2 mm, 8-pin Dual Flat No-Lead (DFN) package. A functional block diagram is shown in Figure 1. The pin configuration and package are shown in Figure 2. Signal pin assignments and functional pin descriptions are provided in Table 1.

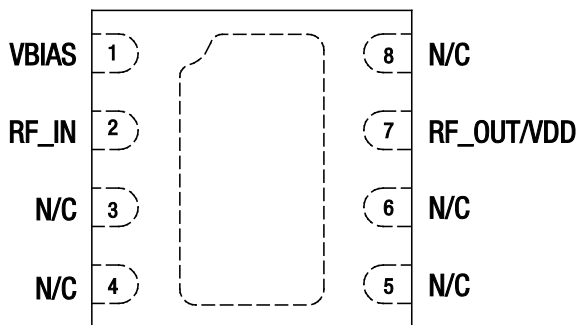

S2396

Figure 2. SKY67013-396LF Pinout – 8-Pin DFN (Top View)

Table 1. SKY67013-396LF Signal Descriptions

Pin #	Name	Description	Pin #	Name	Description
1	VBIAS	Bias for first stage amplifier. External resistor sets current consumption.	5	N/C	No connection. May be connected to ground with no change in performance.
2	RF_IN	RF input. DC blocking capacitor required.	6	N/C	No connection. May be connected to ground with no change in performance.
3	N/C	No connection. May be connected to ground with no change in performance.	7	RF_OUT/VDD	RF output. Apply VDD through RF choke inductor. DC blocking capacitor required.
4	N/C	No connection. May be connected to ground with no change in performance.	8	N/C	No connection. May be connected to ground with no change in performance.

Table 2. SKY67013-396LF Absolute Maximum Ratings

Parameter	Symbol	Minimum	Typical	Maximum	Units
Supply voltage	V _{DD}		3.3	5.5	V
Drain current	I _{DD}		15	50	mA
RF input power	P _{IN}			+10	dBm
Storage temperature	T _{STG}	-65	+25	+125	°C
Operating temperature	T _A	-40	+25	+85	°C
Thermal resistance	Θ _{JC}		128		°C/W

Note: Exposure to maximum rating conditions for extended periods may reduce device reliability. There is no damage to device with only one parameter set at the limit and all other parameters set at or below their nominal value. Exceeding any of the limits listed here may result in permanent damage to the device.

CAUTION: Although this device is designed to be as robust as possible, Electrostatic Discharge (ESD) can damage this device. This device must be protected at all times from ESD. Static charges may easily produce potentials of several kilovolts on the human body or equipment, which can discharge without detection. Industry-standard ESD precautions should be used at all times. The SKY67013-396LF is a Human Body Model (HBM) Class 1A ESD device.

Electrical and Mechanical Specifications

The absolute maximum ratings of the SKY67013-396LF are provided in Table 2. Electrical specifications are provided in Tables 3 (15 mA operation) and 4 (5 mA operation).

Typical performance characteristics of the SKY67013-396LF are illustrated in Figures 3 through 15 (for 15 mA quiescent current), and Figures 16 through 26 (for 5 mA quiescent current).

Table 3. SKY67013-396LF Electrical Specifications: Supply Current = 15 mA (Note 1)
(V_{DD} = 3.3 V, T_A = +25 °C, P_{IN} = -20 dBm, Characteristic Impedance [Z₀] = 50 Ω, Tuning Optimized for 900 MHz, Unless Otherwise Noted)

Parameter	Symbol	Test Condition	Min	Typical	Max	Units
RF Specifications						
Noise Figure	NF	Board and connector insertion losses not de-embedded		0.85	1.10	dB
Small signal gain	IS21I		12.5	14.0		dB
Input return loss	IS11I			23		dB
Output return loss	IS22I			16		dB
Reverse isolation	IS12I			22		dB
3 rd Order Input Intercept Point	IIP3	$\Delta f = 1$ MHz, P _{IN} = -20 dBm/tone	+9	+12		dBm
3 rd Order Output Intercept Point	OIP3	$\Delta f = 1$ MHz, P _{IN} = -20 dBm/tone	+23	+26		dBm
1 dB Input Compression Point	IP1dB		+0.5	+2.5		dBm
1 dB Output Compression Point	OP1dB		+13.5	+15.5		dBm
DC Specifications						
Supply voltage	V _{DD}			3.3		V
Supply current	I _{DD}	Set with external resistor		15		mA

Note 1: Performance is guaranteed only under the conditions listed in this Table.

Table 4. SKY67013-396LF Electrical Specifications: Supply Current = 5 mA (Note 1)
(V_{DD} = 3.3 V, T_A = +25 °C, P_{IN} = -20 dBm, Characteristic Impedance [Z₀] = 50 Ω, Tuning Optimized for 900 MHz, Unless Otherwise Noted)

Parameter	Symbol	Test Condition	Min	Typical	Max	Units
RF Specifications						
Noise Figure	NF	Board and connector insertion losses not de-embedded		1.1		dB
Small signal gain	IS21I			12.5		dB
Input return loss	IS11I			16		dB
Output return loss	IS22I			14		dB
Reverse isolation	IS12I			23		dB
3 rd Order Input Intercept Point	IIP3	$\Delta f = 1$ MHz, P _{IN} = -20 dBm/tone		+9.5		dBm
3 rd Order Output Intercept Point	OIP3	$\Delta f = 1$ MHz, P _{IN} = -20 dBm/tone		+22		dBm
1 dB Input Compression Point	IP1dB			+4		dBm
1 dB Output Compression Point	OP1dB			+15.5		dBm
DC Specifications						
Supply voltage	V _{DD}			3.3		V
Supply current	I _{DD}	Set with external resistor		5		mA

Note 1: Performance is guaranteed only under the conditions listed in this Table.

Typical Performance Characteristics

($V_{DD} = 3.3\text{ V}$, Quiescent Current = 15 mA, $T_A = +25\text{ }^\circ\text{C}$, $P_{IN} = -20\text{ dBm}$, Characteristic Impedance [Z_0] = 50 Ω , Tuning Optimized for 900 MHz, Unless Otherwise Noted)

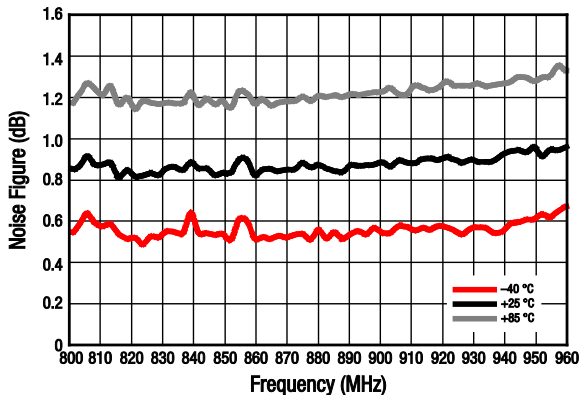

Figure 3. Noise Figure vs Frequency and Temperature, Narrow Band (Includes EVB Insertion Losses)

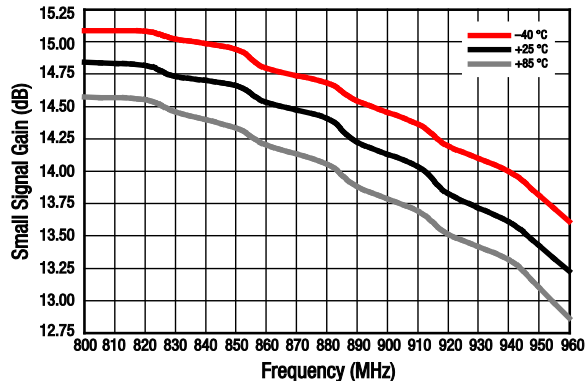

Figure 4. Small Signal Gain (IS21) vs Frequency and Temperature, Narrow Band

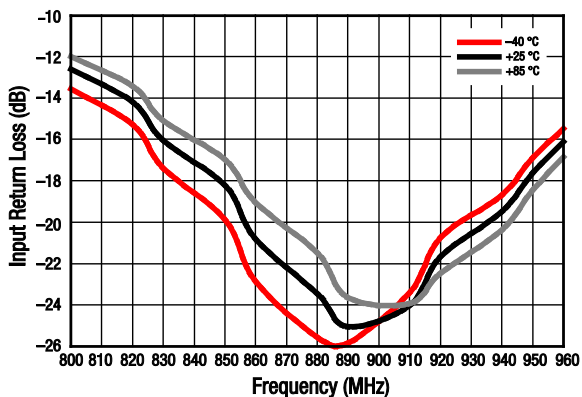

Figure 5. Small Signal Input Return Loss (IS11) vs Frequency and Temperature, Narrow Band

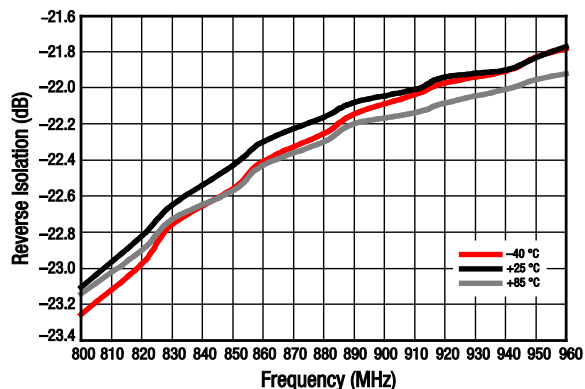

Figure 6. Small Signal Reverse Isolation (IS12) vs Frequency and Temperature, Narrow Band

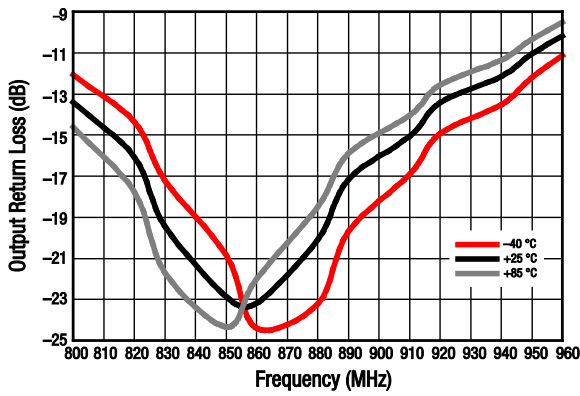

Figure 7. Small Signal Output Return Loss (IS22I) vs Frequency and Temperature, Narrow Band

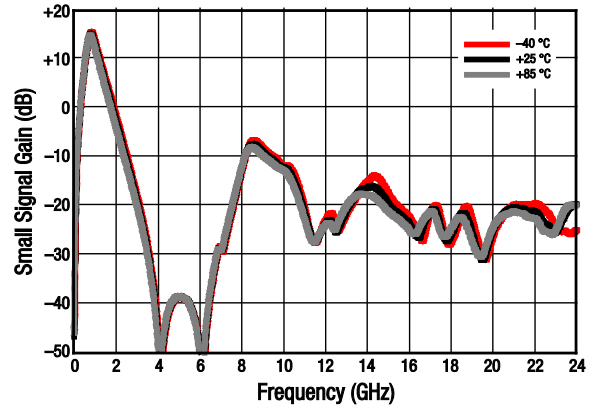

Figure 8. Small Signal Gain (IS21I) vs Frequency and Temperature, Wide Band

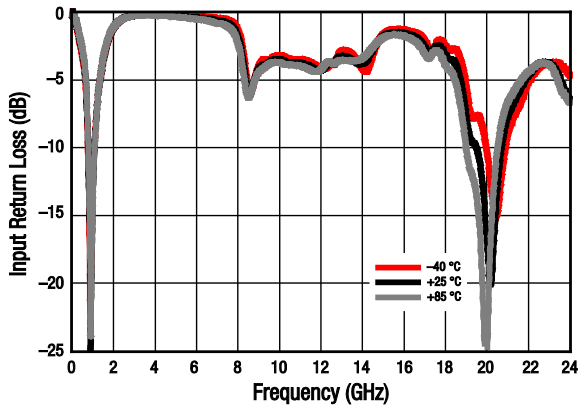

Figure 9. Small Signal Input Return Loss (IS11I) vs Frequency and Temperature, Wide Band

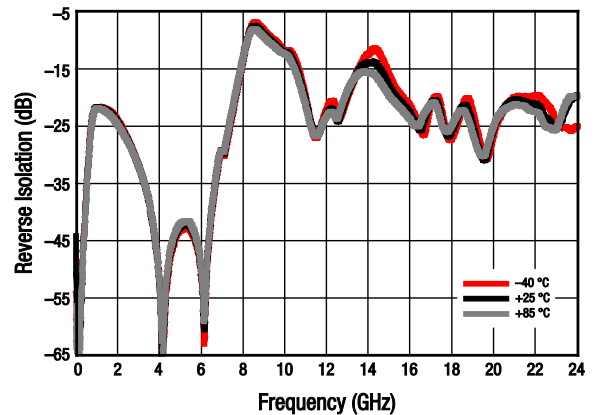

Figure 10. Small Signal Reverse Isolation (IS12I) vs Frequency and Temperature, Wide Band

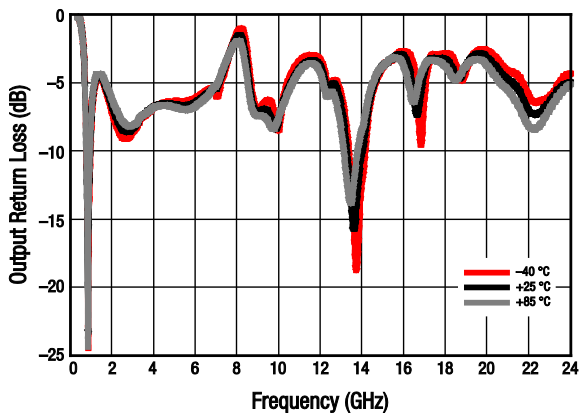

Figure 11. Small Signal Output Return Loss (IS22I) vs Frequency and Temperature, Wide Band

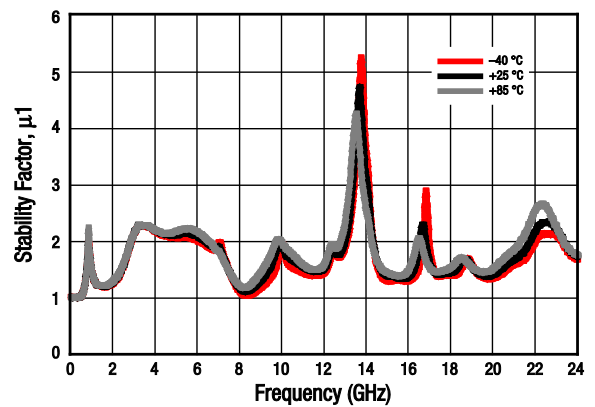

Figure 12. Stability Factor (μ_1) vs Frequency and Temperature, Wide Band

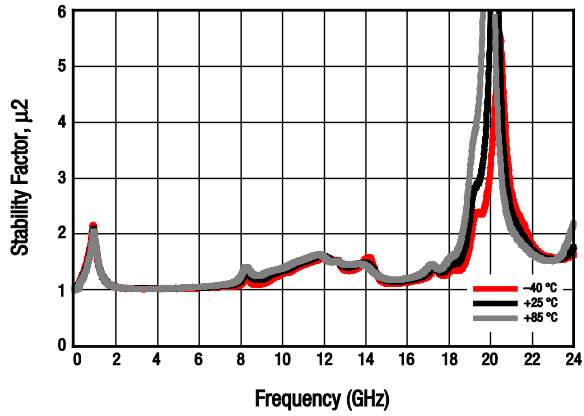

Figure 13. Stability Factor (μ^2) vs Frequency and Temperature, Wide Band

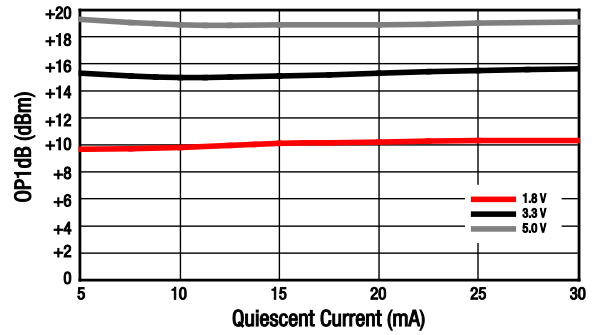

Figure 14. OP1dB vs Quiescent Current

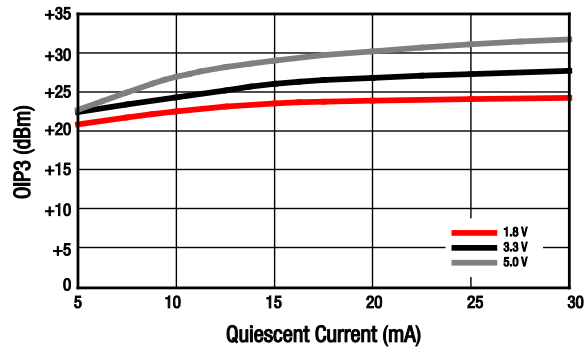

Figure 15. OIP3 vs Quiescent Current

Typical Performance Characteristics

($V_{DD} = 3.3\text{ V}$, Quiescent Current = 5 mA, $T_A = +25\text{ }^\circ\text{C}$, $P_{IN} = -20\text{ dBm}$, Characteristic Impedance [Z_0] = 50 Ω , Tuning Optimized for 900 MHz, Unless Otherwise Noted)

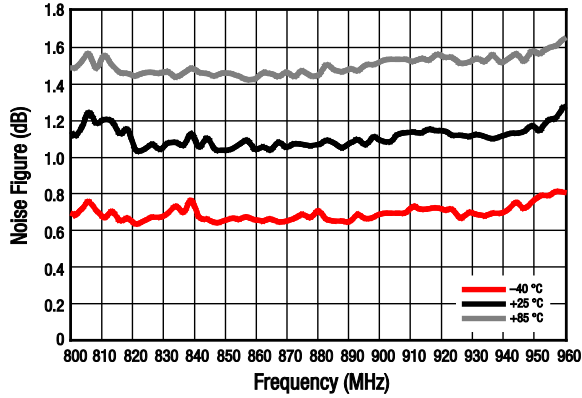

Figure 16. Noise Figure vs Frequency and Temperature, Narrow Band (Includes EVB Insertion Losses)

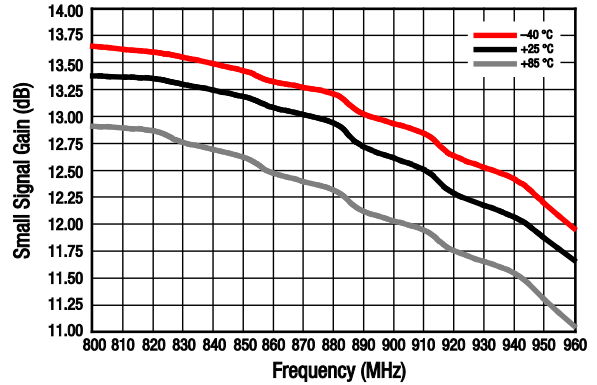

Figure 17. Small Signal Gain (IS21) vs Frequency and Temperature, Narrow Band

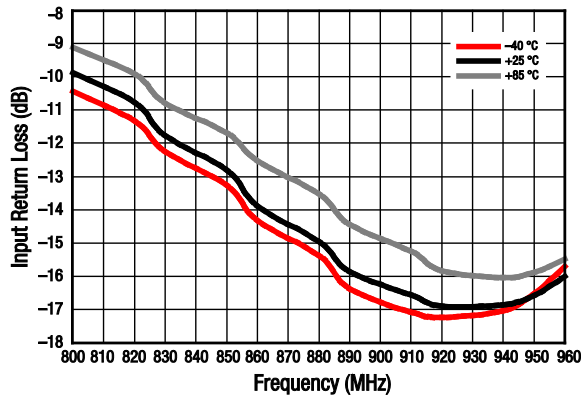

Figure 18. Small Signal Input Return Loss (IS11) vs Frequency and Temperature, Narrow Band

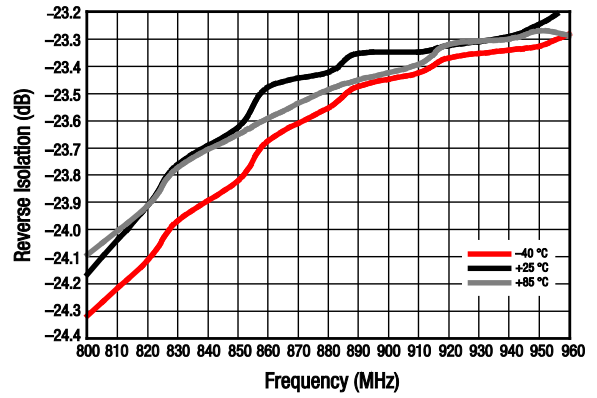

Figure 19. Small Signal Reverse Isolation (IS12) vs Frequency and Temperature, Narrow Band

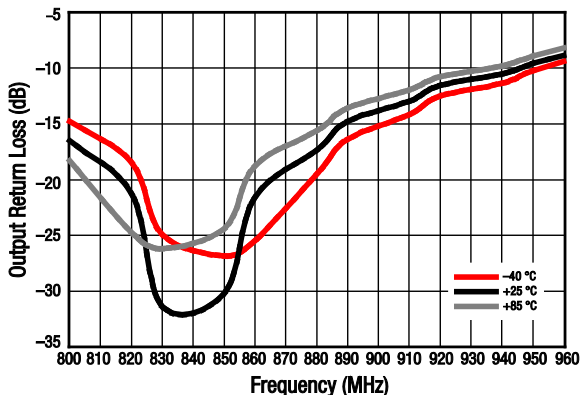

Figure 20. Small Signal Output Return Loss (IS22I) vs Frequency and Temperature, Narrow Band

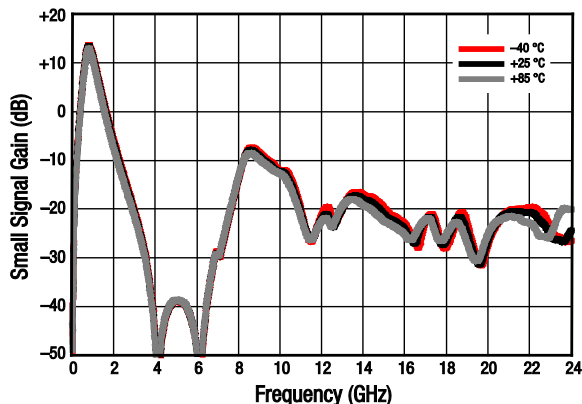

Figure 21. Small Signal Gain (IS21I) vs Frequency and Temperature, Wide Band

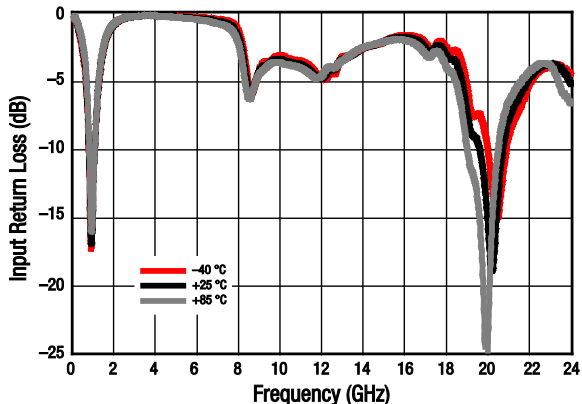

Figure 22. Small Signal Input Return Loss (IS11I) vs Frequency and Temperature, Wide Band

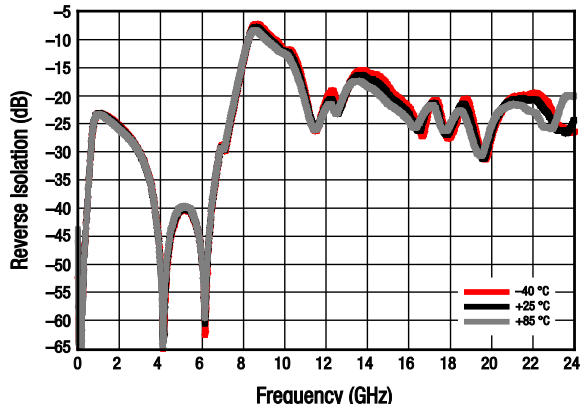

Figure 23. Small Signal Reverse Isolation (IS12I) vs Frequency and Temperature, Wide Band

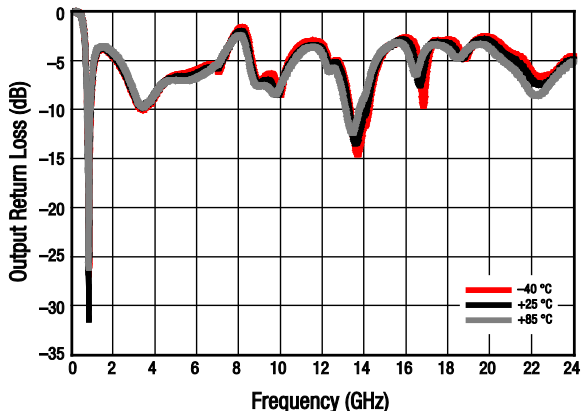

Figure 24. Small Signal Output Return Loss (IS22I) vs Frequency and Temperature, Wide Band

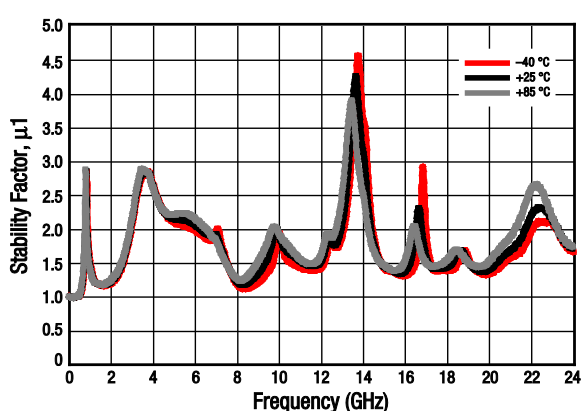

Figure 25. Stability Factor (μ_1) vs Frequency and Temperature, Wide Band

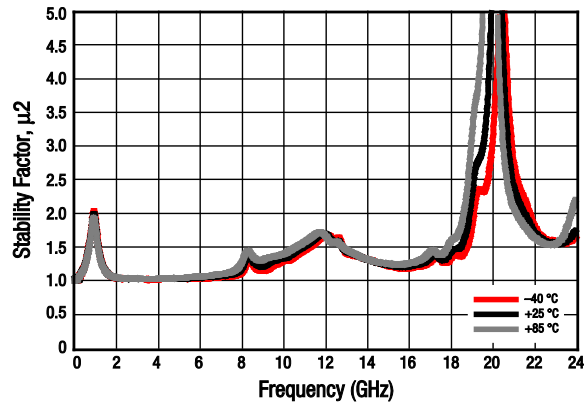

Figure 26. Stability Factor (μ^2) vs Frequency and Temperature, Wide Band

Evaluation Board Description

The SKY67013-396LF Evaluation Board is used to test the performance of the SKY67013-396LF LNA. An assembly drawing for the Evaluation Board is shown in Figure 27. An Evaluation Board schematic diagram is provided in Figure 28. Table 5 provides the Bill of Materials (BOM) list for Evaluation Board components.

Package Dimensions

The PCB layout footprint for the SKY67013-396LF is provided in Figure 29. Typical case markings are shown in Figure 30. Package dimensions for the 8-pin DFN are shown in Figure 31, and tape and reel dimensions are provided in Figure 32.

Package and Handling Information

Instructions on the shipping container label regarding exposure to moisture after the container seal is broken must be followed. Otherwise, problems related to moisture absorption may occur when the part is subjected to high temperature during solder assembly.

THE SKY67013-396LF is rated to Moisture Sensitivity Level 1 (MSL1) at 260 °C. It can be used for lead or lead-free soldering. For additional information, refer to the Skyworks Application Note, *Solder Reflow Information*, document number 200164.

Care must be taken when attaching this product, whether it is done manually or in a production solder reflow environment. Production quantities of this product are shipped in a standard tape and reel format.

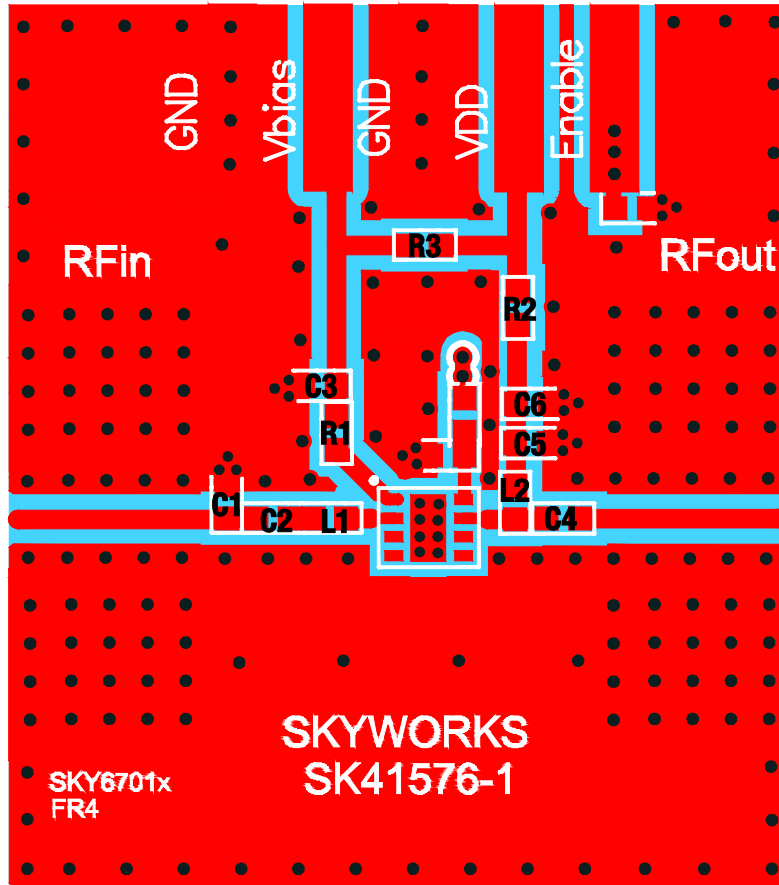

S2394

Figure 27. SKY67013-396LF Evaluation Board Assembly Diagram

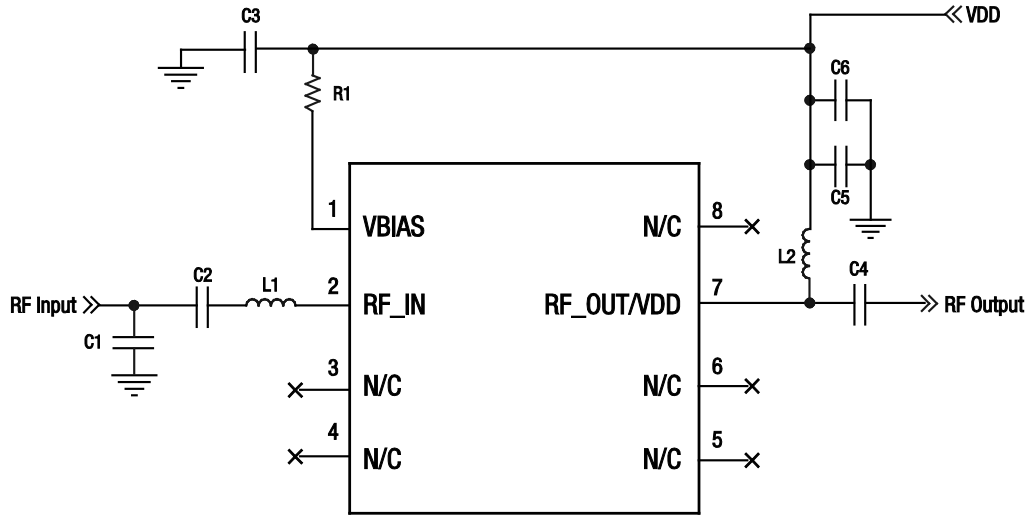

S2397

Figure 28. SKY67013-396LF Evaluation Board Schematic

Table 5. SKY67013-396LF Evaluation Board Bill of Materials

Component	Value	Size	Manufacturer
C1	1.8 pF	0402	Murata GJM
C2	20 pF	0402	Murata GJM
C3	10 pF	0402	Murata GRM
C4	2.4 pF	0402	Murata GRM
C5	10000 pF	0402	Murata GRM
C6	0.5 pF	0402	Murata GRM
L1	10 nH	0402	Murata LQW
L2	8.2 nH	0402	Murata LQG
R1 (Note 1)	6.2 kΩ	0402	Panasonic
R2	0 Ω	0402	Panasonic
R3	0 Ω	0402	Panasonic

Note 1: Use 20 kΩ for R1 to achieve 5 mA of quiescent current with 3.3 VDD.

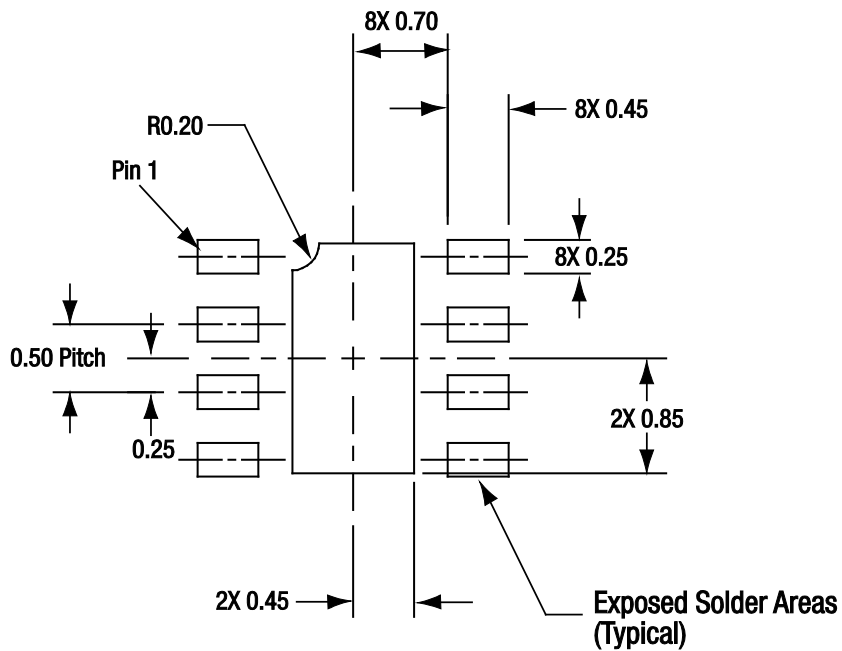

All dimensions are in millimeters

S1413

Figure 29. SKY67013-396LF PCB Layout Footprint (Top View)

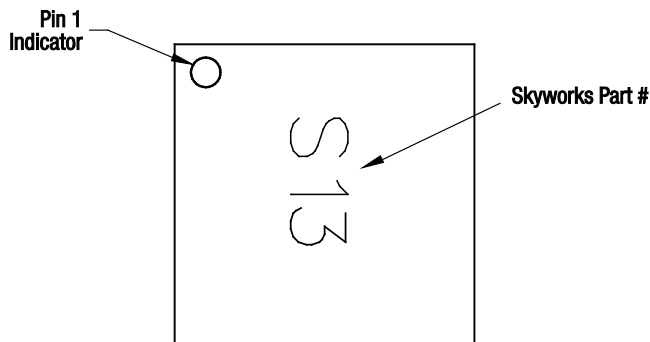
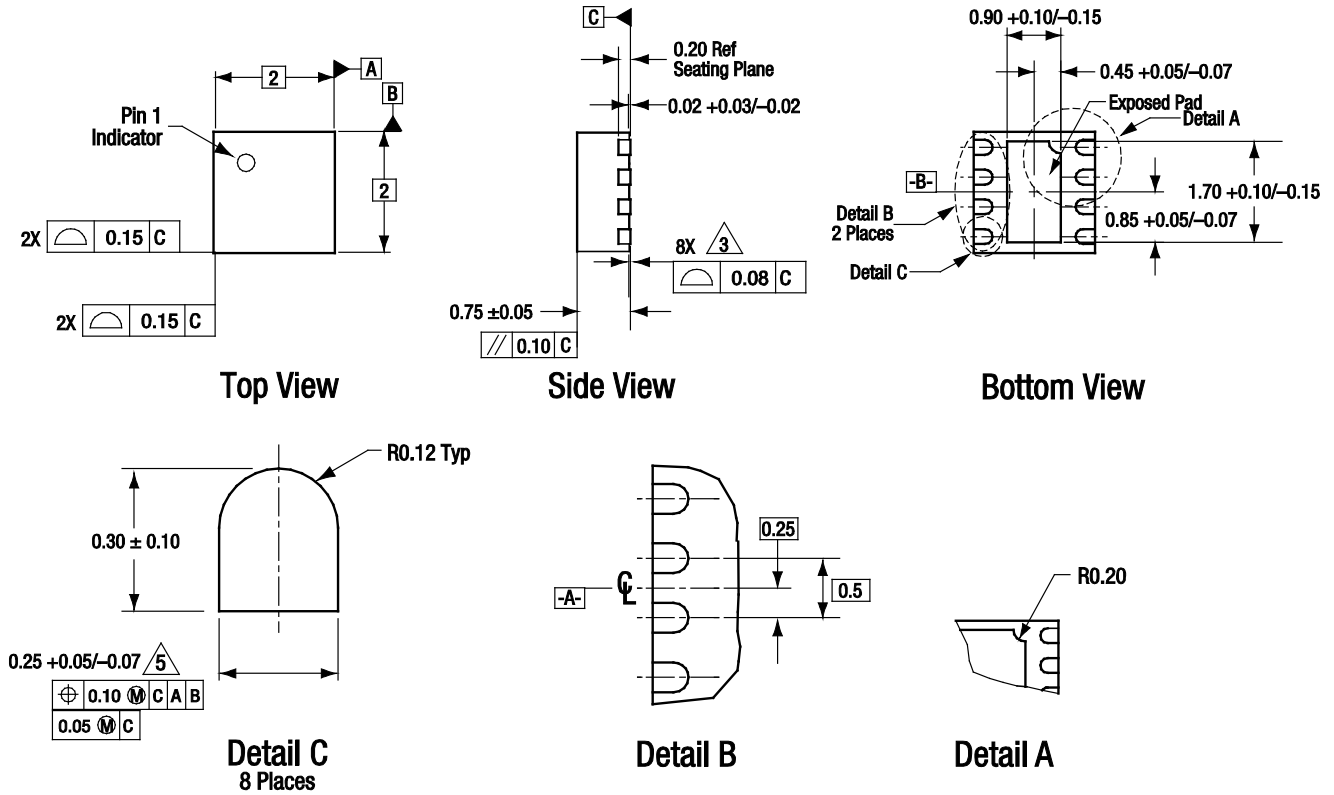

Figure 30. Typical Case Markings (Top View)



All measurements are in millimeters.
 Dimensioning and tolerancing according to ASME Y14.5M-1994.
 Coplanarity applies to the exposed heat sink slug as well as the terminals.
 Plating requirement per source control drawing (SCD) 2504.
 Dimension applies to metallized terminal and is measured between 0.15 mm and 0.30 mm from terminal tip.

S1945

Figure 31. SKY67013-396LF 8-Pin DFN Package Dimensions

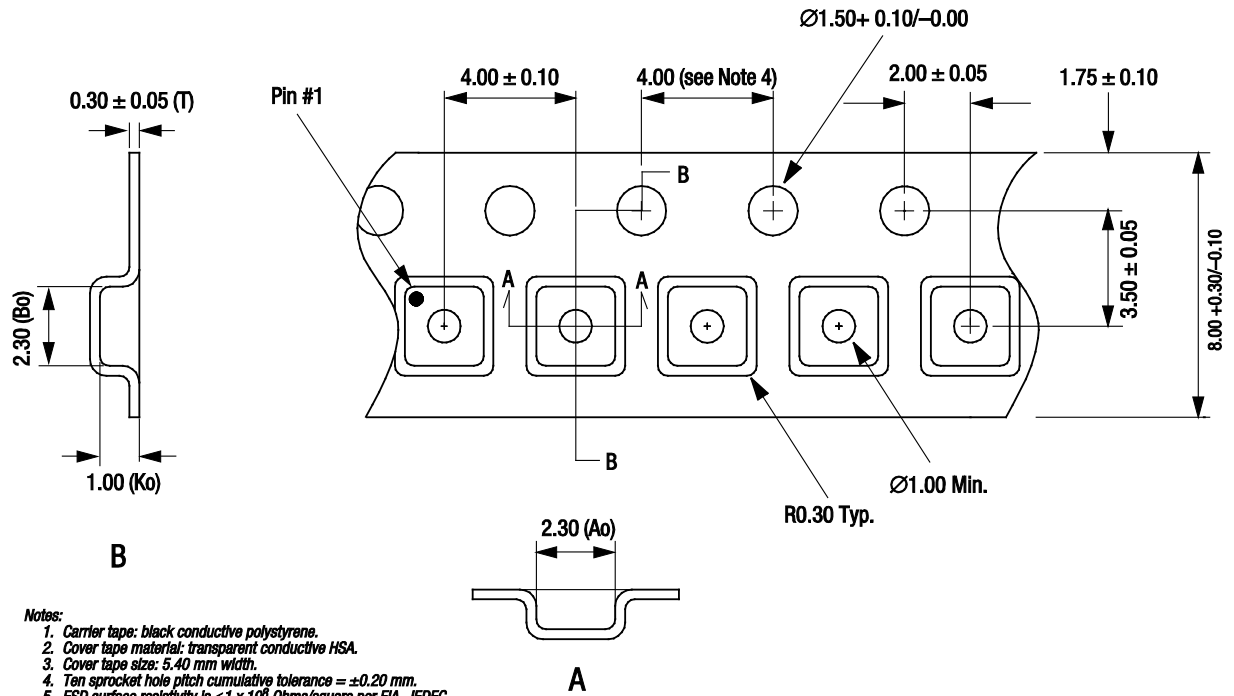

- Notes:
1. Carrier tape: black conductive polystyrene.
 2. Cover tape material: transparent conductive HSA.
 3. Cover tape size: 5.40 mm width.
 4. Ten sprocket hole pitch cumulative tolerance = ± 0.20 mm.
 5. ESD surface resistivity is $\leq 1 \times 10^9$ Ohms/square per EIA, JEDEC tape and reel specification.
 6. Ao and Bo measurement point to be 0.30 mm from bottom pocket.
 7. All measurements are in millimeters.

S1601

Figure 32. SKY67013-396LF Tape and Reel Dimensions

Ordering Information

Model Name	Manufacturing Part Number	Evaluation Board Part Number
SKY67013-396LF Low-Noise, Low-Current Amplifier	SKY67013-396LF	SKY67013-396LF-EVB

Copyright © 2011 Skyworks Solutions, Inc. All Rights Reserved.

Information in this document is provided in connection with Skyworks Solutions, Inc. ("Skyworks") products or services. These materials, including the information contained herein, are provided by Skyworks as a service to its customers and may be used for informational purposes only by the customer. Skyworks assumes no responsibility for errors or omissions in these materials or the information contained herein. Skyworks may change its documentation, products, services, specifications or product descriptions at any time, without notice. Skyworks makes no commitment to update the materials or information and shall have no responsibility whatsoever for conflicts, incompatibilities, or other difficulties arising from any future changes.

No license, whether express, implied, by estoppel or otherwise, is granted to any intellectual property rights by this document. Skyworks assumes no liability for any materials, products or information provided hereunder, including the sale, distribution, reproduction or use of Skyworks products, information or materials, except as may be provided in Skyworks Terms and Conditions of Sale.

THE MATERIALS, PRODUCTS AND INFORMATION ARE PROVIDED "AS IS" WITHOUT WARRANTY OF ANY KIND, WHETHER EXPRESS, IMPLIED, STATUTORY, OR OTHERWISE, INCLUDING FITNESS FOR A PARTICULAR PURPOSE OR USE, MERCHANTABILITY, PERFORMANCE, QUALITY OR NON-INFRINGEMENT OF ANY INTELLECTUAL PROPERTY RIGHT; ALL SUCH WARRANTIES ARE HEREBY EXPRESSLY DISCLAIMED. SKYWORKS DOES NOT WARRANT THE ACCURACY OR COMPLETENESS OF THE INFORMATION, TEXT, GRAPHICS OR OTHER ITEMS CONTAINED WITHIN THESE MATERIALS. SKYWORKS SHALL NOT BE LIABLE FOR ANY DAMAGES, INCLUDING BUT NOT LIMITED TO ANY SPECIAL, INDIRECT, INCIDENTAL, STATUTORY, OR CONSEQUENTIAL DAMAGES, INCLUDING WITHOUT LIMITATION, LOST REVENUES OR LOST PROFITS THAT MAY RESULT FROM THE USE OF THE MATERIALS OR INFORMATION, WHETHER OR NOT THE RECIPIENT OF MATERIALS HAS BEEN ADVISED OF THE POSSIBILITY OF SUCH DAMAGE.

Skyworks products are not intended for use in medical, lifesaving or life-sustaining applications, or other equipment in which the failure of the Skyworks products could lead to personal injury, death, physical or environmental damage. Skyworks customers using or selling Skyworks products for use in such applications do so at their own risk and agree to fully indemnify Skyworks for any damages resulting from such improper use or sale.

Customers are responsible for their products and applications using Skyworks products, which may deviate from published specifications as a result of design defects, errors, or operation of products outside of published parameters or design specifications. Customers should include design and operating safeguards to minimize these and other risks. Skyworks assumes no liability for applications assistance, customer product design, or damage to any equipment resulting from the use of Skyworks products outside of stated published specifications or parameters.

Skyworks, the Skyworks symbol, and "Breakthrough Simplicity" are trademarks or registered trademarks of Skyworks Solutions, Inc., in the United States and other countries. Third-party brands and names are for identification purposes only, and are the property of their respective owners. Additional information, including relevant terms and conditions, posted at www.skyworksinc.com, are incorporated by reference.