

HTU21D click™

1. Introduction

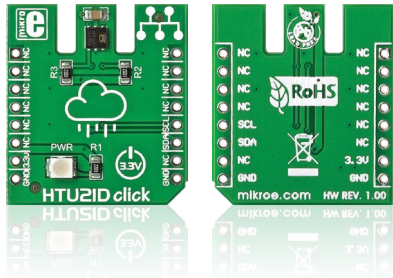

HTU21D click™ carries a high-precision, easy-to-use relative humidity sensor with temperature output. The sensor is plug and play, requiring no calibration to use. The measurement range of HTU21D click™ is from 0 to 100 percents of relative humidity, and -40 to +125 degrees of Celsius. The board communicates with the target microcontroller through mikroBUS™ I2C lines: SCL and SDA (data). It uses a 3.3V power supply only.

2. Soldering the headers

Before using your click™ board, make sure to solder 1x8 male headers to both left and right side of the board. Two 1x8 male headers are included with the board in the package.

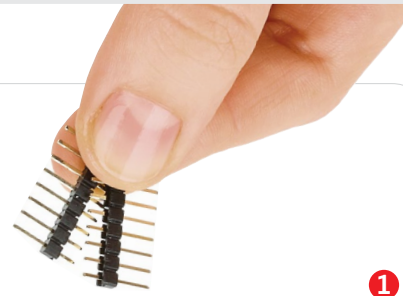

1

2

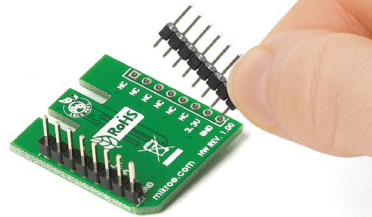

Turn the board upside down so that the bottom side is facing you upwards. Place shorter pins of the header into the appropriate soldering pads.

3

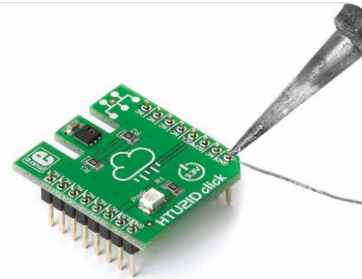

Turn the board upward again. Make sure to align the headers so that they are perpendicular to the board, then solder the pins carefully.

3. Plugging the board in

Once you have soldered the headers your board is ready to be placed into the desired mikroBUS™ socket. Make sure to align the cut in the lower-right part of the board with the markings on the silkscreen at the mikroBUS™ socket. If all the pins are aligned correctly, push the board all the way into the socket.

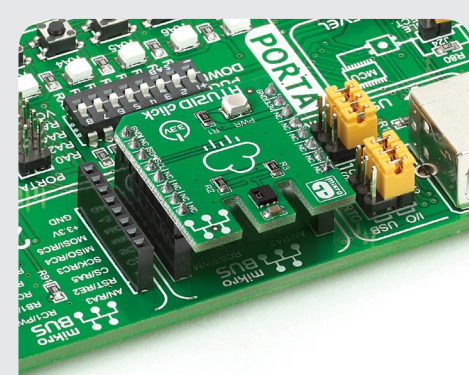
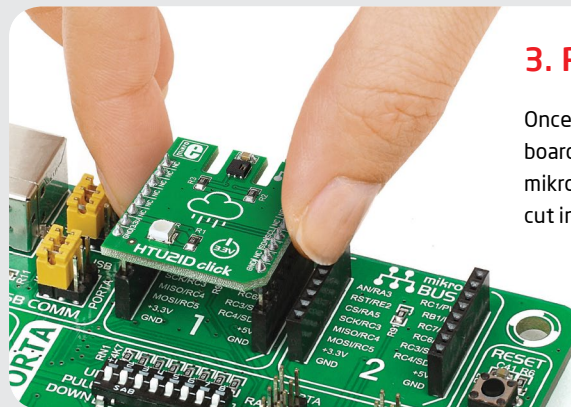

4. Essential features

Since it requires no calibration and uses only 2 communication lines, HTU21D click™ is great for quickly developing reliable environmental sensing nodes. Either for data logging (as in a weather station), or for humidity and temp. control in a HVAC system. The default resolution of the signal is set to 12-bit for relative humidity and 14-bit for temperature readings (you can change the resolution in the range of 8-12 bits for humidity, and 12-14 bits for temperature.)



HTU21D click manual™ v100



5. HTU21D click™ board schematic

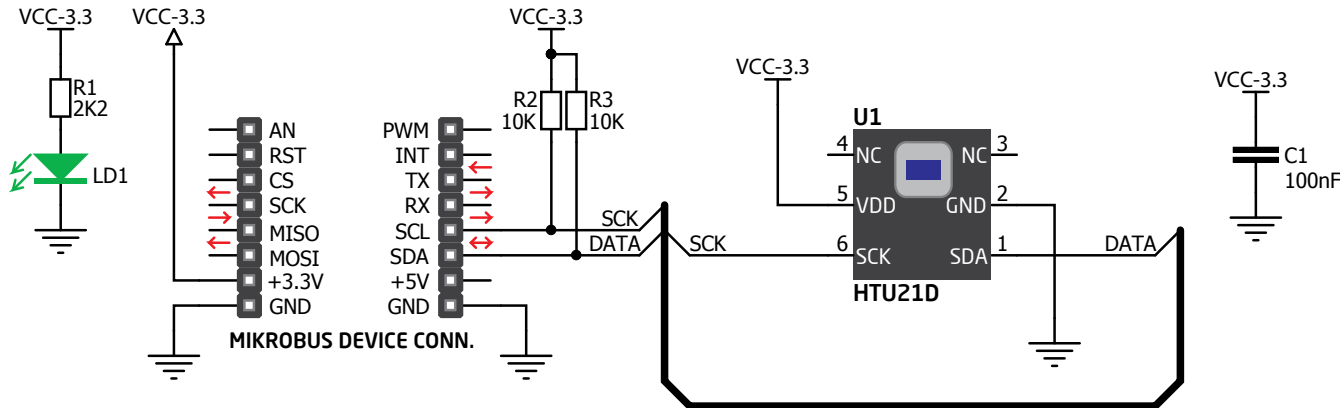

6. Tip on sensor placement



Relative humidity depends on temperature. To get the most accurate measurements from HTU21D click™, it's important to keep the sensor at the same temperature as the environment in which you want to measure the humidity.

7. Code examples

Once you have done all the necessary preparations, it's time to get your click™ board up and running. We have provided examples for mikroC™, mikroBasic™ and mikroPascal™ compilers on our **Libstock** website. Just download them and you are ready to start.



8. Support

MikroElektronika offers **free tech support** (www.mikroe.com/support) until the end of the product's lifetime, so if something goes wrong, we're ready and willing to help!