



HERMETIC SCHOTTKY RECTIFIERS

4 Amp, 45 Volts

Qualified per MIL-PRF-19500/567

Qualified Levels:
JAN, JANTX, and
JANTXV

DESCRIPTION

The 1N6492 hermetic Schottky rectifier is military qualified and ideally suited for output rectifiers and catch diodes in high efficiency, low voltage and high-reliability switching power supplies. Microsemi also offers numerous other products to meet higher and lower power voltage regulation applications.

Important: For the latest information, visit our website <http://www.microsemi.com>.

FEATURES

- JEDEC registered 1N6492.
- Rugged hermetic package, no pressure contacts.
- JAN, JANTX and JANTXV qualifications are also available per MIL-PRF-19500/567.
- RoHS compliant versions available (commercial grade only).

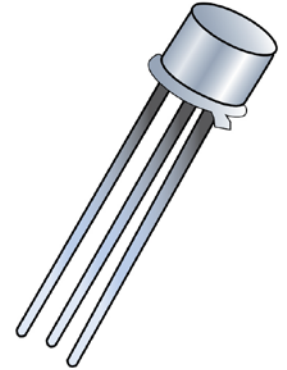

**TO-205AF (TO-39)
Package**

APPLICATIONS / BENEFITS

- Extremely low VF and IR.
- High surge capability.
- Low recovered charge.
- ESD to Class 3A per MIL-STD-750 method 1020.

MAXIMUM RATINGS

Parameters/Test Conditions	Symbol	Value	Unit
Junction and Storage Temperature	T _J and T _{STG}	-65 to +175	°C
Thermal Resistance Junction-to-Ambient	R _{θJA}	175	°C/W
Thermal Resistance Junction-to-Case	R _{θJC}	12	°C/W
DC Blocking Voltage	V _R	45	V
Working Peak Reverse Voltage	V _{RWM}	45	V
Repetitive Peak Inverse Voltage	V _{RRM}	45	V
Non-Repetitive Peak Inverse Voltage	V _{RSM}	54	V
Maximum Average DC Output Current, T _C = +100 °C ⁽²⁾	I _O	3.6	A
Average Forward Current, T _A = +25 °C	I _{F1(AV)}	1.2	A
Average Forward Current (50% duty cycle), T _C = +100 °C ⁽¹⁾	I _{F1(AV)}	4	A
Non-Repetitive Sinusoidal Surge Current	I _{FSM}	80	A

- Notes:**
1. Average current with a 50 percent duty cycle square wave including reverse voltage amplitude equal to the magnitude of full rated V_{RWM}. Derate linearly at 114 mA/°C for T_C > +100 °C (to 0 at T_C = +135 °C); if V_{RWM} = 20, derate I_F (AV) at 62 mA/°C, to 0 at T_C = +165 °C.
 2. Average current with an applied sine wave including reverse voltage equal to the magnitude of full rated V_{RWM}. Derate linearly at 103 mA dc/°C for T_C > +100 °C; if V_{RWM} = 20, derate at 55 mA/°C.

MSC – Lawrence
6 Lake Street,
Lawrence, MA 01841
Tel: 1-800-446-1158 or
(978) 620-2600
Fax: (978) 689-0803

MSC – Ireland
Gort Road Business Park,
Ennis, Co. Clare, Ireland
Tel: +353 (0) 65 6840044
Fax: +353 (0) 65 6822298

Website:
www.microsemi.com

MECHANICAL and PACKAGING

- CASE: Metal TO-205AF (TO-39).
- TERMINALS: Lead/tin or RoHS compliant matte/tin plating (commercial grade only).
- MARKING: Part number and date code.
- POLARITY: Terminal 1 = Anode, Terminal 2 = Open, Terminal 3 = Cathode (Case).
- WEIGHT: 1.064 grams.
- See [Package Dimensions](#) on last page.

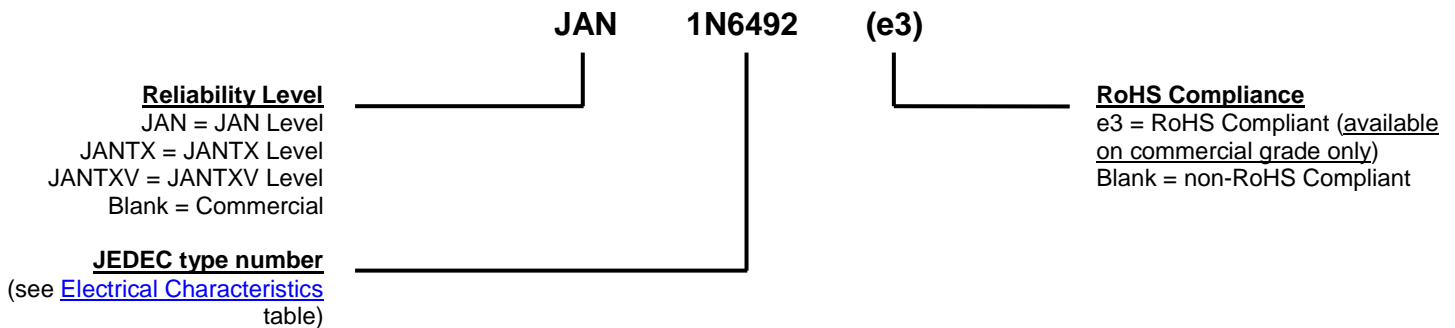
PART NOMENCLATURE

SYMBOLS & DEFINITIONS

Symbol	Definition
C_t	Total Capacitance: The total capacitance in pF at a frequency of 1 MHz and specified voltage.
I_F	Forward Current: The forward current dc value, no alternating component.
I_{FSM}	Maximum Forward Surge Current: The forward current, surge peak or rated forward surge current.
I_o	Average Rectified Output Current: The Output Current averaged over a full cycle with a 50 Hz or 60 Hz sine-wave input and a 180 degree conduction angle.
I_{RM}	Maximum Reverse Current: The maximum reverse (leakage) current that will flow at the specified voltage and temperature.
V_{FM}	Maximum Forward Voltage: The maximum forward voltage the device will exhibit at a specified current.
V_R	Reverse Voltage: The reverse voltage dc value, no alternating component.
V_{RRM}	Repetitive Peak Reverse Voltage: The peak reverse voltage including all repetitive transient voltages but excluding all non-repetitive transient voltages.
V_{RWM}	Working Peak Reverse Voltage: The maximum peak voltage that can be applied over the operating temperature range excluding all transient voltages (ref JESD282-B). Also sometimes known as PIV.

ELECTRICAL CHARACTERISTICS @ 25°C unless specified otherwise.

Part Number	V_{FM1} $I_{FM} = 4 \text{ A (pk)}$	V_{FM2} $I_{FM} = 2 \text{ A (pk)}$	I_{RM} $V_{RM} = 45 \text{ V (pk)}$ $T_A = +125 \text{ °C}$	I_{RM} $V_{RM} = 45 \text{ V (pk)}$ $T_A = +25 \text{ °C}$	C_t $V_R = 5 \text{ V dc,}$ $.01 \leq f \leq 1 \text{ MHz,}$ $V_{SIG} = 15 \text{ mV(p-p)}$
	V (pk)	V (pk)	mA (pk)	mA (pk)	pF
1N6492	.68	.56	20	2.0	450

GRAPHS

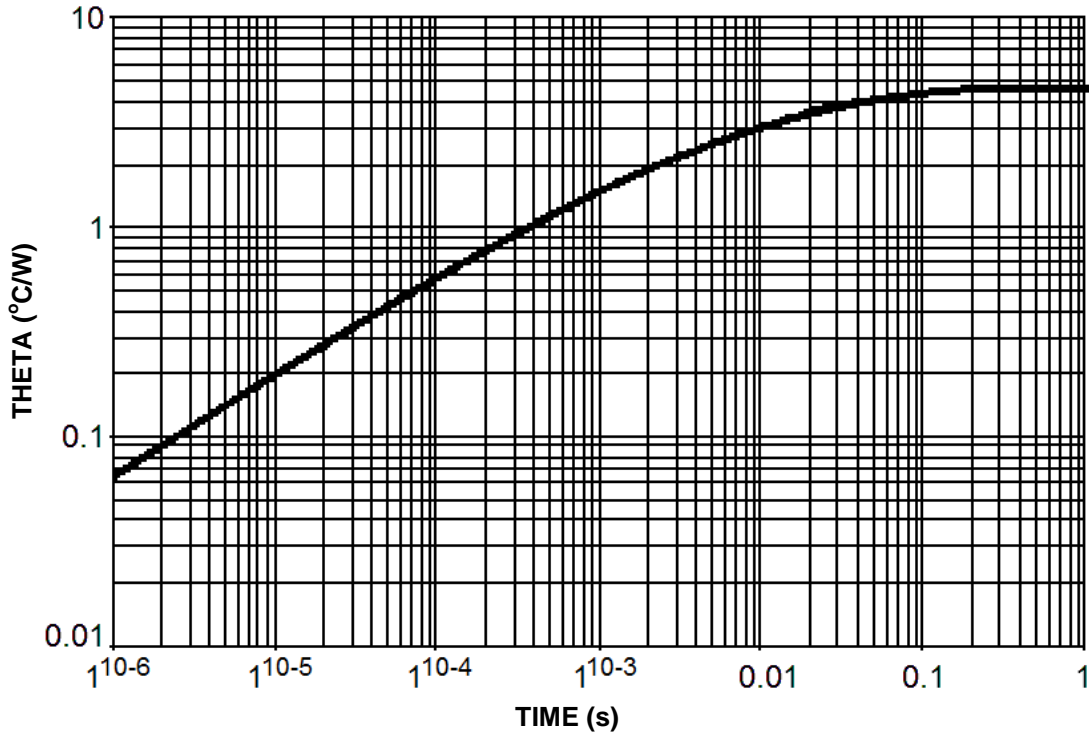

FIGURE 1 – Maximum Thermal Impedance

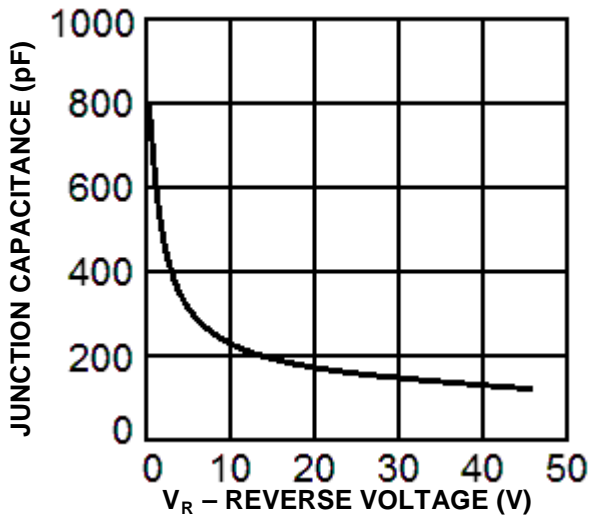

FIGURE 2 – Typical Junction Capacitance vs. Reverse Voltage

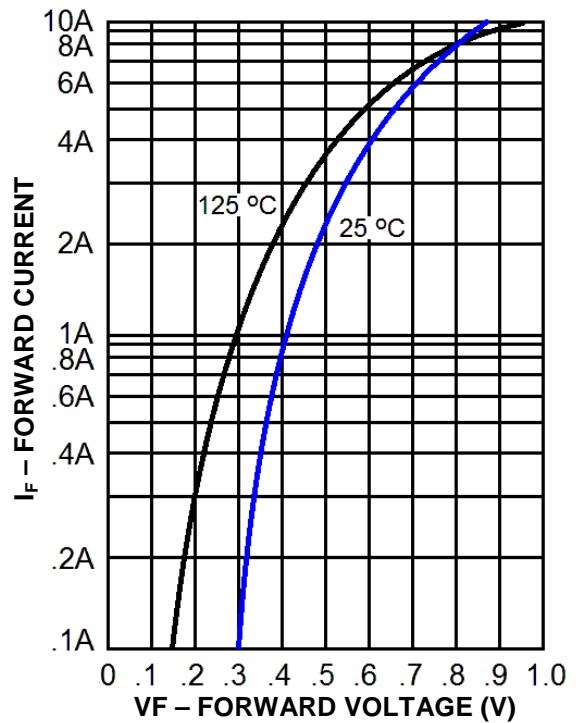

FIGURE 3 – Typical Forward Current vs. Forward Voltage

GRAPHS (continued)

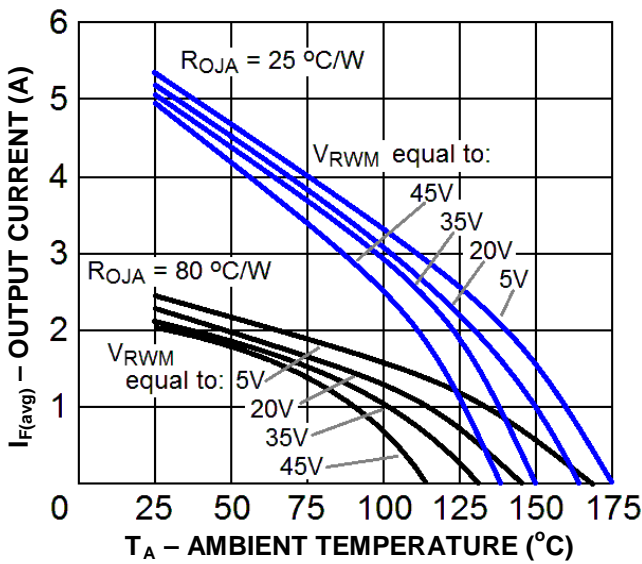

FIGURE 4 – Output Current vs. Ambient Temperature
50% Duty Cycle Application ($I_{F(av)}$ and V_{RWM})

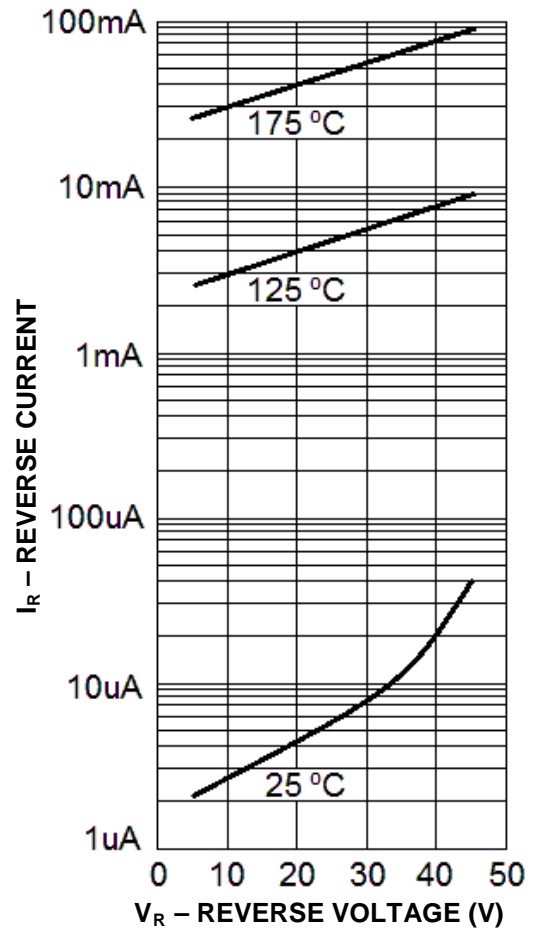
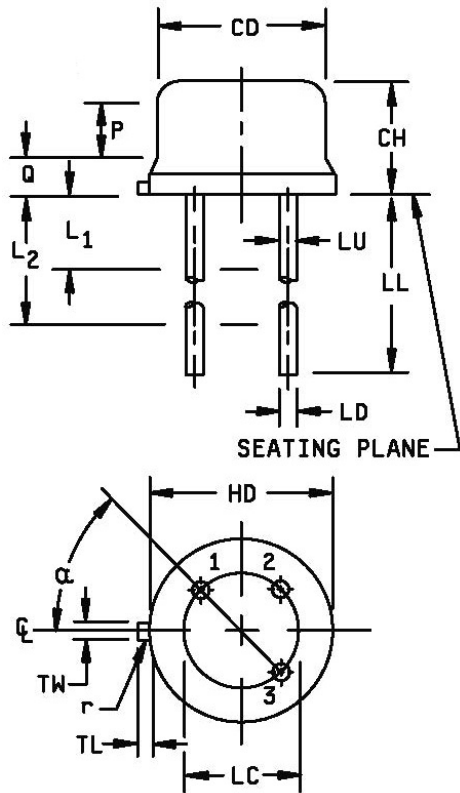
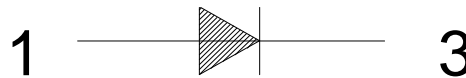

FIGURE 5 – Typical Reverse Current vs. Reverse Voltage

PACKAGE DIMENSIONS

Symbol	Dimensions				Note
	Inches		Millimeters		
	Min	Max	Min	Max	
CD	.305	.335	7.75	8.51	
CH	.160	.180	4.07	4.57	
HD	.335	.370	8.51	9.40	
LC	.200 TP		5.08 TP		7
LD	.016	.021	0.41	0.53	8, 9
LL	.500	.750	12.7	19.05	8, 9
LU	.016	.019	0.41	0.48	8, 9
L ₁		.050		1.27	8, 9
L ₂	.250		6.35		8, 9
P	.100		2.54		6
Q		.040		1.02	5
TL	.029	.045	0.74	1.14	
TW	.028	.034	0.72	0.86	
r		.010		0.254	10
α	45° TP		45° TP		7

Term 1	Anode	
Term 2	Open (no connection)	
Term 3	Cathode (case)	

NOTES:

1. Dimensions are in inches.
2. Millimeters are given for general information only.
3. Beyond radius (r) maximum, TW shall be held for a minimum length of .011 inch (0.279 mm).
4. Dimension TL measured from maximum HD.
5. Outline in this zone is not controlled.
6. Dimension CD shall not vary more than .010 inch (0.25 mm) in zone P. This zone is controlled for automatic handling.
7. Leads at gauge plane .054 +.001, -.000 inch (1.37 +0.03, -0.00 mm) below seating plane shall be within .007 inch (0.18 mm) radius of true position (TP) at maximum material condition (MMC) relative to tab at MMC. The device may be measured by direct methods.
8. LU applies between L₁ and L₂. LD applies between L₂ and LL minimum. Diameter is uncontrolled in L₁ and beyond LL minimum.
9. All three leads.
10. Radius (r) applies to both inside corners of tab.
11. Cathode is electrically connected to the case.
12. In accordance with ASME Y14.5M, diameters are equivalent to Φx symbology.