

FRONT PANEL DESCRIPTION :

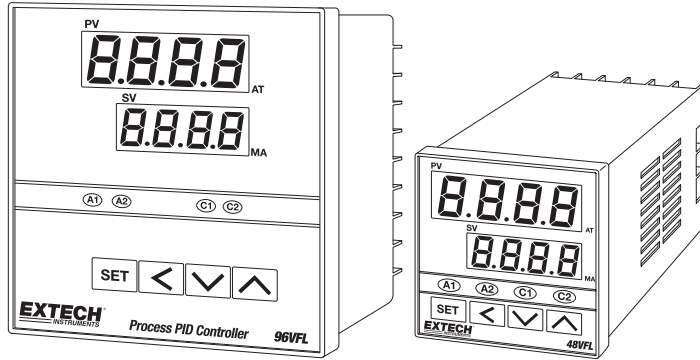

- PV – Process Value
- SV – Setting Value
- AT – Auto tuning LED
- MA – Manual mode LED
- A1 – Alarm 1 LED
- A2 – Alarm 2 LED
- C1 – Control 1 LED
- C2 – Control 2 LED



– SET KEY. Press once to access the next programmable parameter. Press and hold this key for 5 seconds to reset alarm timer.



– UP KEY. Press to increase the set point or parameter value.



– DOWN KEY. Press to decrease the set point or parameter value.



– SHIFT KEY. Press the shift key for 5 seconds to execute Auto Tune process (Yes. 1 mode). To abort an Auto Tune process, press and hold the shift key for 5 seconds.



– Press the SET and UP keys once to return the normal operation.



– LEVEL KEYS. Press and hold the SET & SHIFT keys simultaneously for 5 seconds to select the programming level, and then press the SET key to enter the selected level.



– Press the UP & DOWN keys simultaneously for 5 seconds to access “LnLo” & “LnHi” parameters.

PANEL CUTOUT :

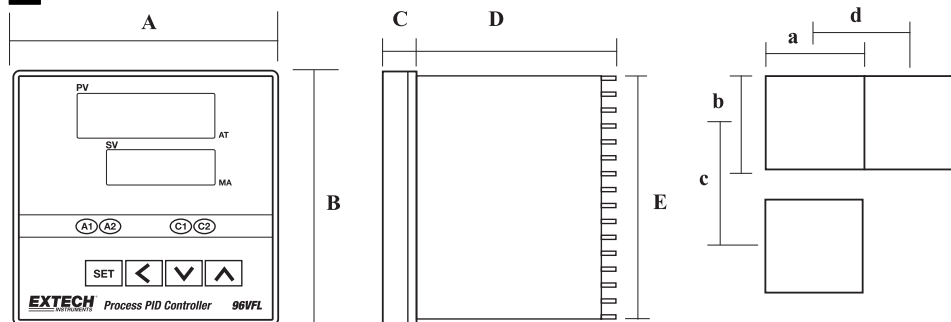

Model	A	B	C	D	E	a	b	c	d
48VFL	48	48	6	100	45	45+0.5	45+0.5	60	48
96VFL	96	96	10	80	91	92+0.5	92+0.5	120	96

(Units: mm)

■ WIRING DIAGRAM 48VFL

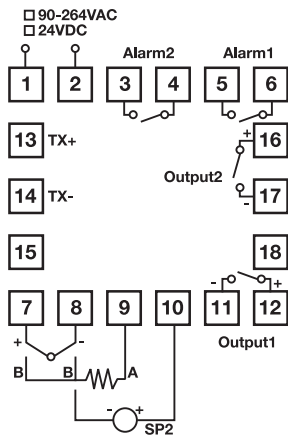

96VFL

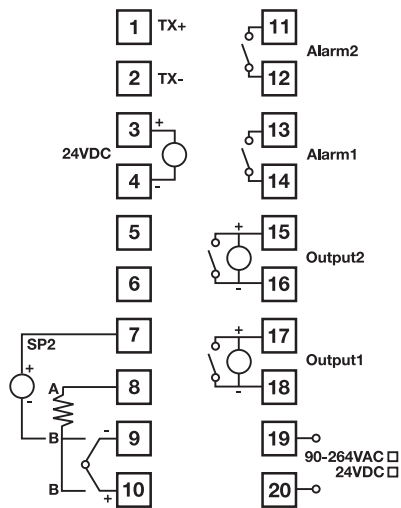

■ Wiring Precautions:



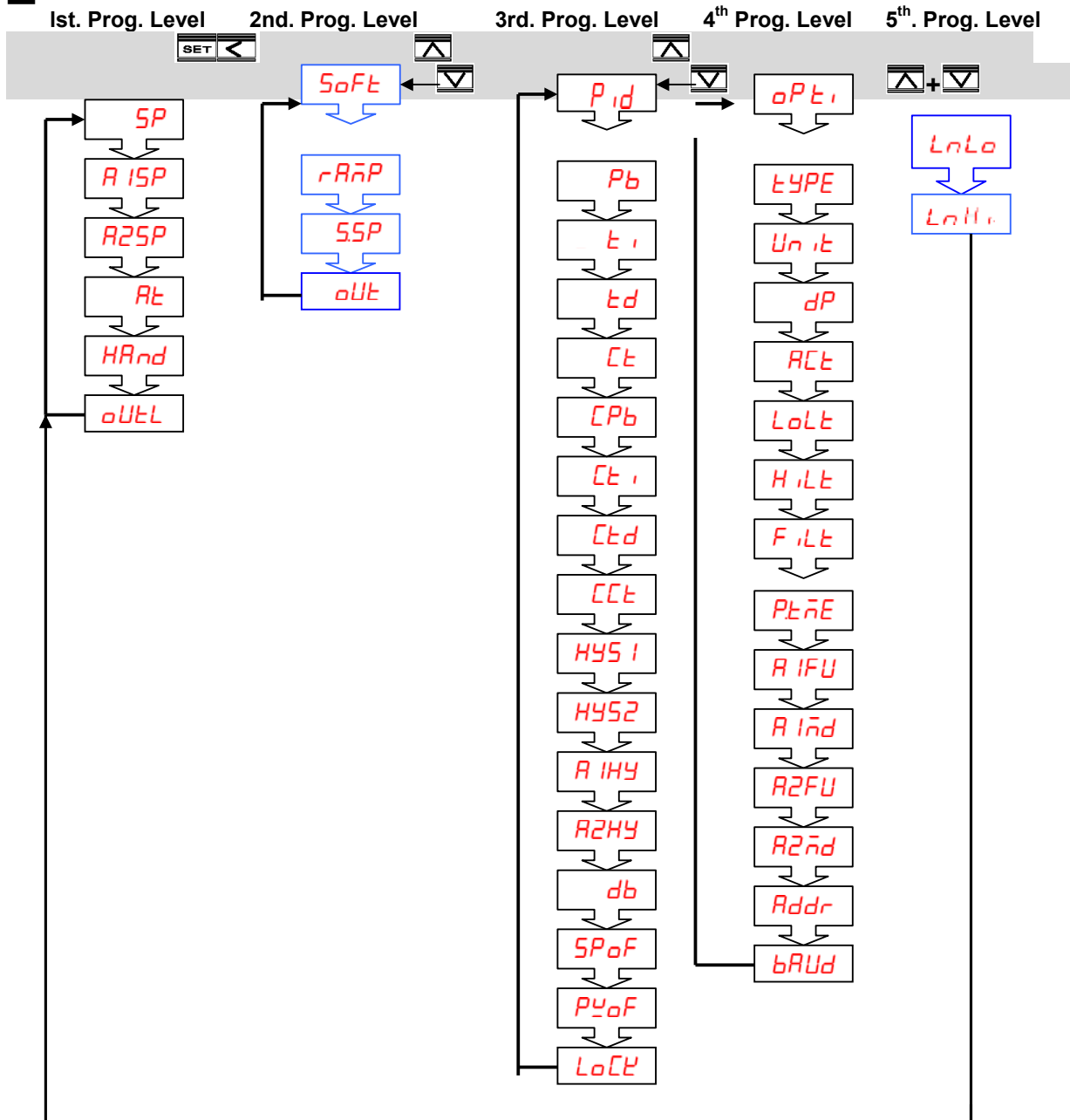

1. Before wiring, verify the controller label for correct model number and options.
2. For thermocouple input, use the appropriate compensation wire. And note the polarity of input signal.
3. To avoid noise induction, keep input signal wires away from instrument power lines, load lines and power lines of other electrical equipment.

PROGRAMMING LEVEL PARAMETERS



1. When 2nd Output (Cooling) is not selected, CPb · Cti · Ctd · HYS2 and db parameters are not available.
2. When Pb≠0.0 · HYS1 will be skipped.
3. When CPb≠0.0 · HYS2 will be skipped.
4. When Pb=0.0 · ti · td will be skipped.
5. When CPb=0.0 · Cti · Ctd will be skipped.

PARAMETER DESCRIPTION :

<i>LEVEL</i>	LEVEL Selection								
	Press   keys for at least 5 seconds to access Soft Level. Use  or								
	 key to select programming level. Then press  key to enter this level.								
	<table border="1"> <thead> <tr> <th>LEVEL</th> <th>Description</th> </tr> </thead> <tbody> <tr> <td><i>Soft</i></td> <td>SoFt Level</td> </tr> <tr> <td><i>Pid</i></td> <td>PID Level</td> </tr> <tr> <td><i>Opt</i></td> <td>Option Level</td> </tr> </tbody> </table>	LEVEL	Description	<i>Soft</i>	SoFt Level	<i>Pid</i>	PID Level	<i>Opt</i>	Option Level
LEVEL	Description								
<i>Soft</i>	SoFt Level								
<i>Pid</i>	PID Level								
<i>Opt</i>	Option Level								

USER LEVEL

CODE	DESCRIPTION	RANGE	Default
<i>SP</i>	Set point value of control	LoLt – HiLt	500
<i>A1SP</i>	Alarm 1 set point value/Timer set value while A1FU is set to T.on or T. off, the unit can be HH.MM or MM.SS. It depends on the “P.tnE” parameter.	-1999 – 9999/ 00.00~99.59	10
<i>A2SP</i>	Alarm 2 set point value/ Timer set value while A2FU is set to T.on or T. off, the unit can be HH.MM or MM.SS. It depends on the “P.tnE” parameter.	-1999 – 9999/ 00.00~99.59	10
<i>At</i>	<p><i>no</i> : Auto-tuning is disable</p> <p><i>YES.1</i> : Standard type auto-tuning.</p> <p>Autotune PV is compared wit SV during auto tuning.</p> <p><i>YES2</i> : Low PV type auto-tuning.</p> <p>PV is compared with SV-10%FS during Auto-tuning.</p>	<p><i>no</i></p> <p><i>YES.1</i></p> <p><i>YES2</i></p>	no
<i>Hand</i>	<p><i>no</i> : Disable the manual mode Manual control</p> <p><i>YES</i> : Enable the manual mode.</p>	<p><i>no</i></p> <p><i>YES</i></p>	no
<i>OUTL</i>	Output percentage. Adjustable when “Hand” is set to “Yes”	-100.0 – 100.0	0.0

SOFT LEVEL

Code	Description	Range	Default
<i>rRnP</i>	Ramp rate for the process value to limit an abrupt Change of process (°C/min)	0 - 9999 (0.0 – 999.9)	0.0
<i>SSP</i>	Set point value of soft-start	LoLt – HiLt	0
<i>OUT</i>	Output percentage of soft-start	0.0 - 100.0	100.0

PID LEVEL

CODE	DESCRIPTION	RANGE	Default
<i>Pb</i>	Proportional band variable. Set to 0.0 for ON/OFF control mode	0.0-300.0%	10.0
<i>t_i</i>	Integral time (Reset). This value is automatically calculated by activating the Autotune function. If desired, the user can later	0-3600sec	240

	adjust this parameter to better suit the application. When PB=0.0, this parameter will be not available. When set to zero, Pb & td \neq 0 for PD control		
<i>td</i>	Derivative (Rate). This value is automatically calculated by activating the Auto tune function. If desired, the user can later adjust this parameter to better suit the application. When PB=0.0, this parameter will be not available. When set to zero, Pb & td \neq 0 for PI control	0-900sec	60
<i>ct</i>	Proportional cycle time of output 1	0-100sec	15
<i>CPb</i>	Proportional band variable for secondary control output (cooling). Set 0.0 for ON/OFF	0.0-300.0%	10.0
<i>cti</i>	Integral time for secondary control output. When PB=0.0, this parameter will be not available. When set to zero, Pb & td \neq 0 for PD control	0-3600sec	240
<i>ctd</i>	Derivative time for secondary control output. When Pb=0.0, this parameter will be not available. When set to zero, Pb & ti \neq 0 for PI control	0-900sec	60
<i>ctt</i>	Proportional cycle time of output 2	0-100sec	15
<i>HYS1</i>	Hysteresis for ON/OFF control on output 1	0-2000(0.0-200.0)	1
<i>HYS2</i>	Hysteresis for ON/OFF control on output 2	0-2000(0.0-200.0)	1
<i>A1HY</i>	Hysteresis of alarm 1	0-2000	1
<i>A2HY</i>	Hysteresis of alarm 2	0-2000	1
<i>db</i>	Dead band value. This defines the area in which output 1 and output 2 are both active (negative value) or the area in which output 1 and output 2 are both inactive (positive value)	-1000-1000 (-100.0-100.0)	0
<i>SPoF</i>	Set point offset. This value will be added to SV to perform control. It mainly used to eliminate offset error during Pb control	-1000-1000 (-100.0-100.0)	0
<i>PVoF</i>	Process value offset. Permits the user to offset the PV indication from the actual PV	-1000-2000 (-100.0-200.0)	0
<i>LoCK</i>	Parameter lock. This security feature locks out selected levels or single parameters prohibiting tampering and inadvertent programming changes		0100
	0000	All parameters are locked out	
	0001	Only SP is adjustable	
	0010	Only USER level is adjustable	
	0011	USER and PID levels are adjustable	
	0100	USER,PID,OPTI levels are adjustable	
	0101	USER, SOFT, PID, OPTI levels are adjustable	
	0101~0111	All parameters in all levels are unlocked	
1000~1111	1000=0000,1001=0001,1010=0010,1011=0011,1100=0100 The only difference is that Output 2 is unlocked		



OPTION LEVEL

CODE	DESCRIPTION	RANGE	Default		
<i>TYPE</i>	Input type selection.	Refer to figure.	K		
	tYPE			RANGE(°C)	RANGE(°F)
	J			-50 ~ 1000	-58 ~ 1832
	K			-50 ~ 1370	-58 ~ 2498
	T			-270 ~ 400	-454 ~ 752
	E			-50 ~ 750	-58 ~ 1382
	B			0 ~ 1800	32 ~ 3272
	R			0 ~ 1750	32 ~ 3182
	S			0 ~ 1750	32 ~ 3182
	N			-50 ~ 1300	-58 ~ 2372
	C			-50 ~ 1800	-58 ~ 3272
	D-PT			-200 ~ 850	-328 ~ 1652
	J-PT			-200 ~ 650	-328 ~ 1202
LINE	-1999 ~ 9999				
<i>Unit</i>	Unit of process value <i>°C</i> : Degrees C <i>°F</i> : Degrees F <i>Eng</i> : Engineer units for linear input	<i>°C</i> <i>°F</i> <i>Eng</i>	°C		
<i>dP</i>	Decimal point selection 0000 : No decimal point 000.0 : 0.1 resolution 00.00 : 0.01 resolution, used for linear input only 0.000 : 0.001 resolution, used for linear input only	0000 000.0 00.00 0.000	0000		
<i>ACT</i>	Output 1 control action. <i>rev</i> : Reverse action for heating <i>dir</i> : Direct action for cooling	<i>rev</i> <i>dir</i>	<i>rev</i>		
<i>LoLt</i>	Low limit of span or range. Set the low limit lower than the lowest expected SV and PV display	Full range	0		
<i>HiLt</i>	High limit of span or range. Set the high limit higher than highest expected SV and PV display	Full range	1000		
<i>FiLt</i>	Software filter.	0.0-99.9	10.0		
<i>PEāE</i>	Time scale for timer alarm. <i>HHāā</i> Hours:Minutes; <i>āāSS</i> Minutes:Seconds	00.00~99.59	00.00		
<i>A1FU</i>	Alarm 1 function. Refer to alarm section for details If A1FU=None, the alarm function is cancelled	None, Hi, Lo, dif.H, dif.L, bd.Hi , bd.Lo t.on, t.oFF	<i>d iFH</i>		
<i>A1āā</i>	Alarm 1 mode. Refer to alarm mode section for detail..	none, Stdy, Lath, St.La	<i>nonE</i>		
<i>A2FU</i>	Alarm 2 function. Refer to alarm function section for detail	none, Hi, Lo, dif.H,	<i>d iFL</i>		





	If A2FU=None, it means alarm function is cancelled.	dif.L, bd.Hi, bd.Lo t.on, t.oFF	
<i>A2nd</i>	Alarm 2 mode. Refer to alarm mode section for details	none, Stdy, Lath, St.La	<i>nonE</i>
<i>Addr</i>	Controller address. For use with PC RS-485 interface	0 - 255	0
<i>BAUD</i>	Baud rate. 2.4k=2400bps, 4.8k=4800 bps, 9.6k=9600 bps, 19.2k=19200 bps	2.4k, 4.8k 9.6k, 19.2k	9.6k

Code	Description	Range	Default
<i>LnLo</i>	Low Scale of Linear Input	-1999~9999(-199.9~999.9)	0.0
<i>LnHi</i>	High Scale of Linear Input	-1999~9999(-199.9~999.9)	100.0

Scaling for Linear Input

1. Press and hold the UP and DOWN keys simultaneously for 5 seconds to access the “LnLo” parameter.
2. Adjust “LnLo” setting to correspond to the low scale; after adjustment, press  key once to access “LnHi”
3. Adjust “LnHi” setting to correspond to the high scale; after adjustment press  key once to exit

ALARM FUNCTION

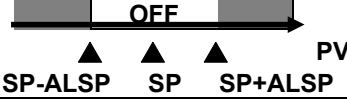
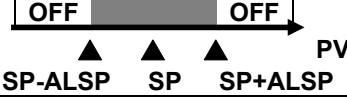
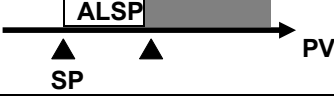
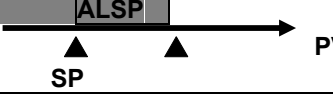
A1FU/A2FU	ALARM TYPE	ALARM OUTPUT OPERATION
<i>nonE</i>	Alarm function OFF	Output OFF
<i>Hi</i>	Process high alarm	
<i>Lo</i>	Process low alarm	
<i>difH</i>	Deviation high alarm	
<i>difL</i>	Deviation low alarm	
<i>bdHi</i>	Band high alarm	
<i>bdLo</i>	Band low alarm	
<i>t.on</i>	On-timer	
<i>t.oFF</i>	Off-timer	

ALARM MODE

A1MD/A2MD	DESCRIPTION
<i>none</i>	Normal alarm mode/ When timer function is selected, with the PV<SV, the timer function is disabled
<i>Stdy</i>	Standby mode When selected, in any alarm function, an alarm on power-up is prevented. The alarm is enabled only when the process value reaches the alarm set point. Also known as “Startup inhibit” (useful for avoiding alarm trips during startup)
<i>LATCH</i>	Latch mode. When selected, the alarm output and indicator “latch” when the alarm occurs. The alarm output and indicator will remain energized even if the alarm condition has been cleared (unless the power to the meter is removed)
<i>SELA</i>	Standby and latch mode

■AUTOMATIC AND MANUAL OUTPUT CONTROL

Automatic control is the normal mode of controller operation. In automatic control mode the controller automatically adjusts the control output percentage, using PID, to bring the PV equal to the SV. The PID parameters Pb, Ti and Td can be automatically determine using the Auto Tune procedure.

Manual control allows the user to manually drive the output percentage from 0.0 to 100.0%. To access the manual mode, set the “*HArd*” parameter to “*YES*”, the right-most decimal (MA) on the SV display will flash. The “*oUeL*” parameter will then alternately display *oUeL* and the process value. The output percentage can then be adjusted using the UP or DOWN keys. To abort the manual control, simply set “*HArd*” to “*no*”.

■AUTO TUNE

In order to automatically set the PID parameters in the PID level (“Pb” proportional band, “ti: integral time, also known as ‘reset’, and “td” derivative time, also known as ‘rate’), first adjust the controller’s set point to a value that closely approximates the application at hand. Set the “*At*” parameter to “*YES.1*” for standard applications or “*YES.2*” for minimizing SV overshoot (see diagram below). The right-most decimal point (AT) on the PV display will flash in Auto Tune mode. This procedure will run two cycle oscillations. After that, the controller performs PID control with the “learned” PID value to verify the results. Finally the PID values will be entered into the nonvolatile memory and then starts the Fuzzy enhanced PID control. The auto tune process can last from several minutes up to two hours, depending on the process in question. A time out error will occur if the auto tune process can not be completed within two hours, in this case, try to set the PID parameters manually. To abort an auto tune process, simply set the “*At*” parameter to “*no*”.

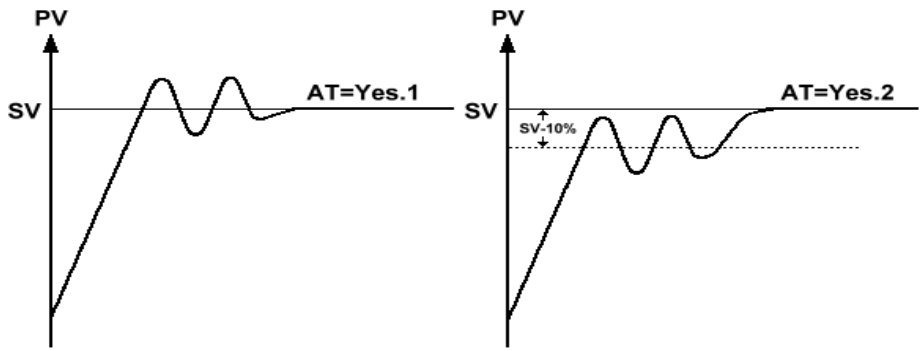

The controller can also be set to ON/OFF, PI, PD and P control mode. Set $P_b = 0$ for ON/OFF control mode. Set $t_i = 0$ for PD control mode. Set $t_d = 0$ for PI control mode and $t_i, t_d = 0$ for P control mode. The Hysteresis (dead band) for ON/OFF control operates as follows:

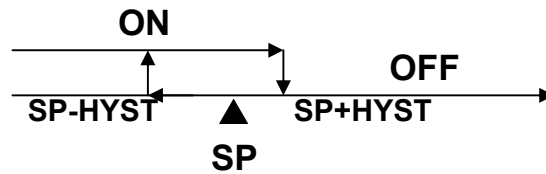

When the second control output (output 2) is used, the proportional band of output 2 and the dead band interact as detailed below:

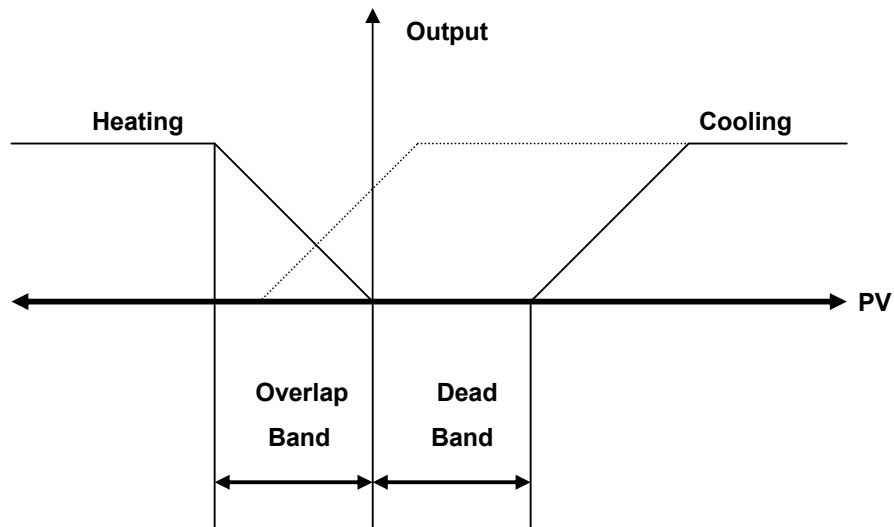

■ ERROR MESSAGE AND TROUBLESHOOTING

Symptom	Probable	Solution
oPEr	- Sensor break error - Sensor not connected	- Replace sensor - Check that the sensor is connected correctly
ADEr	- A/D converter damage	- Unit must be repaired or replaced - Check for outside source of damage such as transient voltage spikes
AEr	- Auto tune time out error	Set Pb, ti, td manually
Keypad not functioning	- Keypad is locked - Keypad is defective	- Set " LoCE " to an appropriate value - Have unit repaired
Process value unstable	- Improper setting of Pb, Ti, Td and CT	- Start AT process to set Pb, Ti, Td automatically - Set Pb, Ti, Td manually
No heat or output	- No heater power or fuse open - Output device defective or incorrect output used	- Check output wiring and fuse - Replace output device
LEDs and display not lighting up	- No power to controller - SMPS failure	- Check power lines connection - Replace or repair meter
Process Value changed abnormally	- Electromagnetic Interference (EMI) or Radio Frequency Interference (RFI)	- Suppress arcing contacts in system to eliminate high voltage spike sources. Separate the sensors and the controller wiring from "noisy" power lines. Ground heaters
Entered data lost	- EEPROM error	- Replace or repair meter

Controller Overview

Controller Wiring

The controller must be wired before use. The controller's input, outputs, and AC power are connected via its rear terminals. Refer to the wiring diagram for details.

Programming Menus

The controller uses a menu-based programming format. The menu levels are USER, PID, OPTION, and SOFT-START. Each menu includes a series of parameters that customize the controller. The menu structure and parameter descriptions are detailed in the instructions on reverse side of this sheet.

Inputs

The controller accepts an input from a Thermocouple, RTD, or Analog signal. Wire the input as shown in the wiring diagram. The measurement (PV for Process Variable) is displayed on the controller's top LED readout in red.

Setpoint Value (SV)

The Setpoint Value (SV) is the process application target value. For example, in an oven application the desired oven temperature is the SV. This SV is changed adjusted as described in the operating instructions. The SV is shown on the controller's lower LED display digits in green.

Control Outputs

The control outputs (C1 & C2) are to be wired to an external control device such as a heater, valve, switch, etc. The controller automatically adjusts external devices to bring the Process Variable (PV) in line with the Setpoint Variable (SV). Available outputs are Relay, Pulsed DC, and 4-20mA Analog Output.

Tuning

The controller must be tuned for every new application. It is strongly recommended that user run the Auto Tune function (AT). Note that the controller must be wired and ready to go before Auto Tune is started. Auto Tune optimizes the controller's response to exactly match the characteristics and dynamics of the process at hand. Although auto tuning will be sufficient in most cases, there may be times when manual adjustments are required. Qualified personnel can Manually Tune the controller using the PID parameters in the PID Menu Level. Note that improper tuning can cause sever process disturbances; Use Auto Tuning when possible. Again, use Auto Tune whenever possible.

Alarm Outputs

The controller has alarm output relays (A1 & A2) that can be used to switch on/off a lamp, sound a buzzer, shut down a heater, etc. at a programmed alarm setpoint. Refer to the discussion of Alarms on the main instruction page.

System Reset

To revert all of the parameters to their original factory default settings, press and hold the UP and DOWN arrow keys simultaneously while turning the controller ON. Release the keys after the display switches on.

Security LOCK

To lock the controller, in order to avoid setpoint and program tampering, refer to the information provided in this manual for the 'LOCK' parameter.

Specifications

General Specifications

Display	Dual 7-segment 4-digit LED: Red digits for Process Variable (PV) and green digits for Setpoint Variable (SV)
Display range	-1999 to 9999
Indicating accuracy	± (0.2% full scale + 1 digit)
Display update rate	4 readings per second
Output status indication	Front panel Alarm (A1 and A2) and Control (C1 and C2) status LED's inform the user when an output switches on or off.
Out-of-range indication	PV display flashes.
'No input' indication	PV displays 'OPEN' when input terminals are disconnected.
Auto Tune indication	Right-most decimal on the PV display flashes while the controller is in the auto tune mode.
Calibration data	Stored in non-volatile memory along with user parameter edits.
Meter construction	Case is ABS plastic and the front panel is drip- and dust-proof Lexan material (NEMA and IEC IP55 equivalent)
Power requirement	90 to 264VAC 50/60Hz (automatically accommodates any voltage between 90 to 264VAC)
Power consumption	< 5VA
Insulation Resistance	> 50MΩ
Noise rejection	Common Mode: 120 dB; Normal Mode: 60 dB (typical)
Operating conditions	14 to 122°F (-10 to 50°C); 90% Relative Humidity max.
Storage temperature	-4 to 140°F (-20 to 60°C)
Panel cut-out dimensions	1.77 x 1.77" ±0.02" (45.0 x 45.0mm ±0.5mm) for 48VFL 3.62 x 3.62" ±0.02" (92.0 x 92.0mm ±0.5mm) for 96VFL

Thermocouple Input Specifications

Thermocouple (TC) types	J, K, T, E, B, R, S, N, and C (user programmable)
Temp. Indication Accuracy	<1000 degrees ±3.6F (2.0C) >1000 degrees ±7.6F (4.0C)
TC Break protect	Upscale and Downscale
Lead wire effect	0.015% / ohm
Input impedance	> 10MΩ
Repeatability	0.83°C
Temperature stability	5uV/°C typical
TC Ranges	Type K: -58 to 2498°F (-50 to 1370°C) Type J: -58 to 1830°F (-50 to 1000°C) Type B: 32 to 3272°F (0 to 1800°C) Type T: -454 to 752°F (-270 to 400°C) Type E: -58 to 1382°F (-50 to 750°C) Type R: 32 to 3182°F (0 to 1750°C) Type S: 32 to 3182°F (0 to 1750°C) Type N: -58 to 2372°F (-50 to 1300°C) Type C: -58 to 3272°F (-50 to 1800°C)

RTD Input Specifications

RTD type	Platinum 100Ω (DIN or JIS)
RTD range	-328 to 1202°F (-200 to 650°C)
Break protection	Up- and down-scale
Lead wire effect	0.015° / Ohm
Repeatability	0.2°C

Analog (Linear) Input Specifications

Current Input	4 to 20mA DC (2.7Ω input impedance)
Voltage Input	1 to 5V DC (>10MΩ input impedance)
Display range	-1999 to 9999 digits
Repeatability	Within 1 digit

Relay and Pulse DC Output Specifications

Relay outputs	SPST (dry contact) relays can switch up to 5 Amps @ 110V AC or 24VDC (for resistive loads only)
Pulsed DC outputs	0 to 24 VDC output (drives resistive loads to 250Ω max.)
Control actions	Indirect or reverse acting (heating) and direct acting (cooling)
Control types	ON/OFF control with Hysteresis (dead band) Time proportioning control (for relay or pulsed DC output) Standard proportional output (analog output)
Automatic tuning	Push-button activation. Automatically tunes the proportional band and integral/derivative times.
Manual Tuning	Proportional Band (Pb): 0.0 to 300.0% of Full Scale Integral time or 'Reset' (Ti): 0 to 3000 seconds (includes anti-reset wind-up) Derivative time or 'Rate' (Td): 0 to 900 seconds Cycle Time: 0 to 100 seconds (set to '0' for 4-20mA output) Hysteresis: 0.0 to 25.5% of Full Scale

ALARM Output Specifications

Alarm relay outputs	SPST, dry contact relay can switch up to 3 Amps @ 110VAC; (for Resistive Loads)
Alarm modes	Deviation, Absolute, and Band Alarms with dead band (Hysteresis) adjustment.

ANALOG Output Specifications

Analog output	4-20mA DC
Load limits	600Ω max.
Programming	Set Cycle Time (Ct) to '0' to enable the analog output

Warranty

*FLIR Systems, Inc. warrants this Extech Instruments brand device to be free of defects in parts and workmanship for **one year** from date of shipment (a six month limited warranty applies to sensors and cables). If it should become necessary to return the instrument for service during or beyond the warranty period, contact the Customer Service Department for authorization. Visit the website www.extech.com for contact information. A Return Authorization (RA) number must be issued before any product is returned. The sender is responsible for shipping charges, freight, insurance and proper packaging to prevent damage in transit. This warranty does not apply to defects resulting from action of the user such as misuse, improper wiring, operation outside of specification, improper maintenance or repair, or unauthorized modification. FLIR Systems, Inc. specifically disclaims any implied warranties or merchantability or fitness for a specific purpose and will not be liable for any direct, indirect, incidental or consequential damages. FLIR's total liability is limited to repair or replacement of the product. The warranty set forth above is inclusive and no other warranty, whether written or oral, is expressed or implied.*

Calibration, Repair, and Customer Care Services

FLIR Systems, Inc. offers repair and calibration services for the Extech Instruments products we sell. NIST certification for most products is also provided. Call the Customer Service Department for information on calibration services available for this product. Annual calibrations should be performed to verify meter performance and accuracy. Technical support and general customer service is also provided, refer to the contact information provided below.

Support Lines: U.S. (877) 439-8324; International: +1 (603) 324-7800

Technical Support: Option 3; E-mail: support@extech.com

Repair & Returns: Option 4; E-mail: repair@extech.com

Product specifications are subject to change without notice

Please visit our website for the most up-to-date information

www.extech.com

FLIR Commercial Systems, Inc., 9 Townsend West, Nashua, NH 03063 USA

ISO 9001 Certified

Copyright © 2013 FLIR Systems, Inc.

All rights reserved including the right of reproduction in whole or in part in any form

www.extech.com